

# the RANGE

Products for perfect punching & forming

SYSTEMS  
CONTROLS  
SENSORS

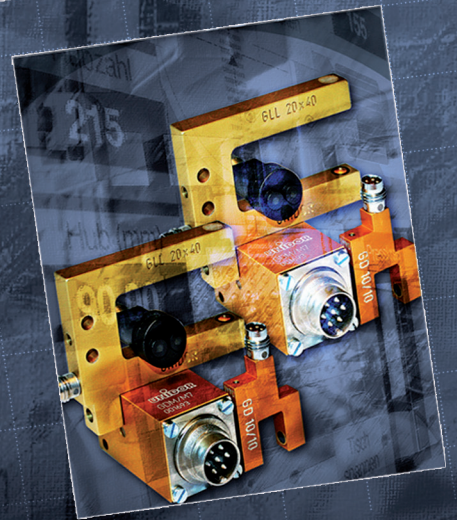
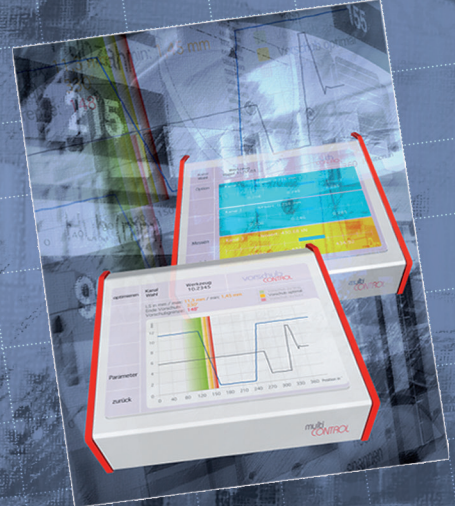
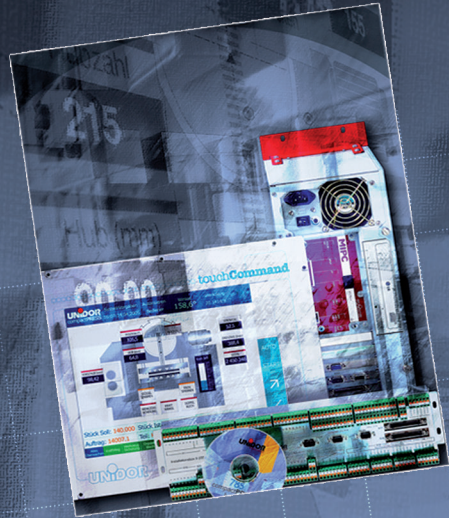

**Lincoln**

when you count, count on us



# Products for perfect punching & forming

2

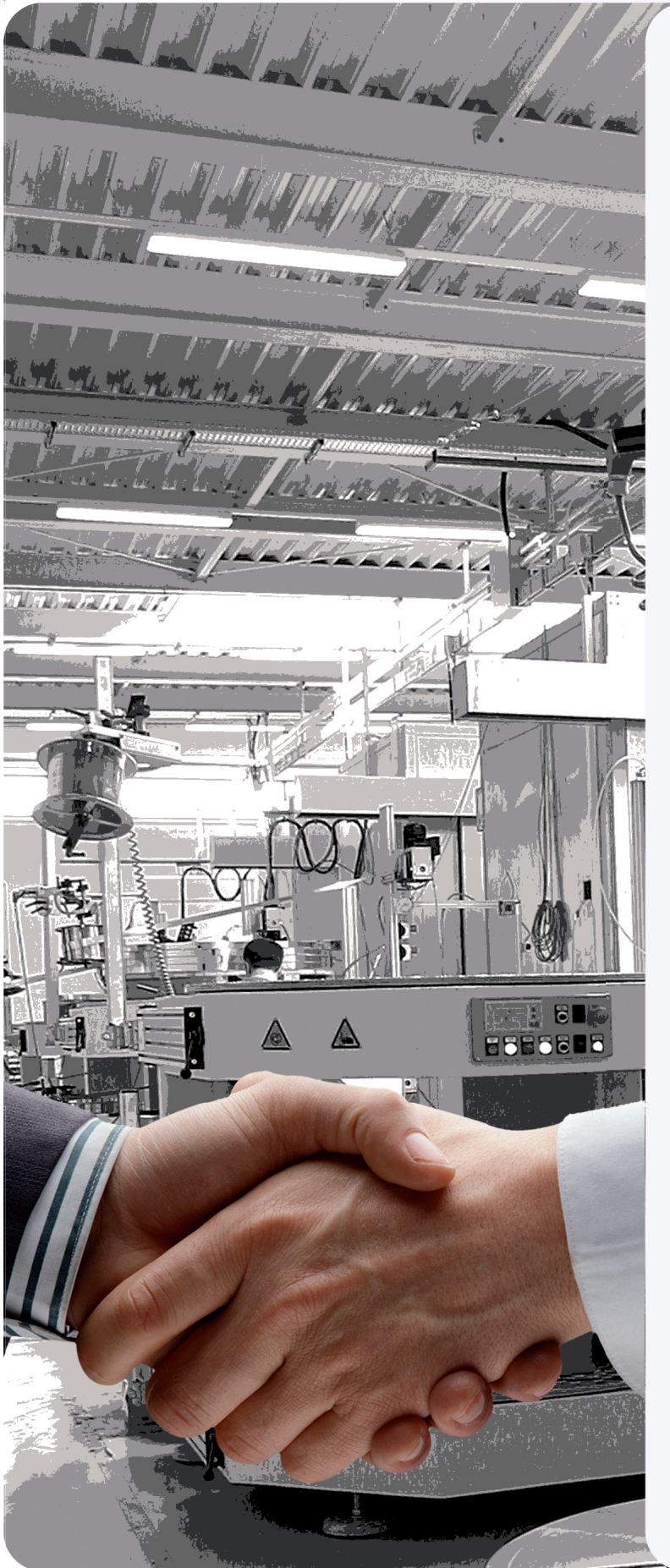

## Contents

3	<i>when you count, count on us</i> Products for perfect punching & forming
5	<i>why you need unidor</i> 3 product lines and 4 applications
7	<i>the sensors</i> digital, analog, special
9	<i>the controls</i> from multi to smart
13	<i>the systems</i> compactPRESS & powerPRESS
15	<i>compactPRESS</i> for an infinite range of applications
21	<i>powerPRESS</i> for holistic automation
23	<i>compactPC eco</i> an IPC completely without hard disk
25	<i>Machine modernisation</i> Turn old into new
27	<i>we're there when you need us</i> the expert team



A controlled approach





**Together.** Quality products with the latest technology are one thing. Our vast experience in process optimisation for punching and forming is something else. So don't just regard us as suppliers of sensors, controls and systems – see us as a **competence team** with a wealth of experience in practice and with countless ideas for improvement to offer.

We want to establish the status quo at your side in production on the machine and on the tool, and then prepare a technical document on how to increase your productivity and quality with existing resources and new concepts.

See us as **experts** who, in close partnership with you, create possibilities for getting more out of your production and for obtaining more and more reliability with your machines and tools.

You can therefore expect a complete **all-round package** from UNiDOR: From the initial expert consultation through the prompt delivery and installation of the optimum technology for your requirements right up to the ongoing after-sales service. Use our forums and presentation to stay constantly up-to-date.

Let us look for **optimum solutions** in a continuing association based on partnership, and let us inspire one another to constantly push back the limits of feasibility.



**Future.** The future of punching and forming is changing fast: More complex, faster, more precise and everything perfectly documented right up to the highest stroke rate. The innovative product demands of your customers and the constant pressure of costs force you to extend the **limits of feasibility** with products and tools day after day.

It is therefore becoming more and more important to comprehensively visualise the punching and forming process in order to be able to exactly optimise and control each work step on this basis. Only by knowing exactly what is happening at all times is it possible to meet the customers' demands for perfect production and quality results and creates the technological lead that guarantees orders today and even more in the future.

To achieve this, UNiDOR supplies perfect products, a wealth of ideas and a whole lot of service. From special sensors through delicate monitoring units right up to comfortable, universal measuring systems – you have exactly the equipment you need to have the punching and forming process precisely under control at all times.

Our products guarantee that you reliably control the production process even at the limit of technical feasibility and achieve **excellent results** with maximum profitability at all times.



# 3 product lines in 4 applications

4

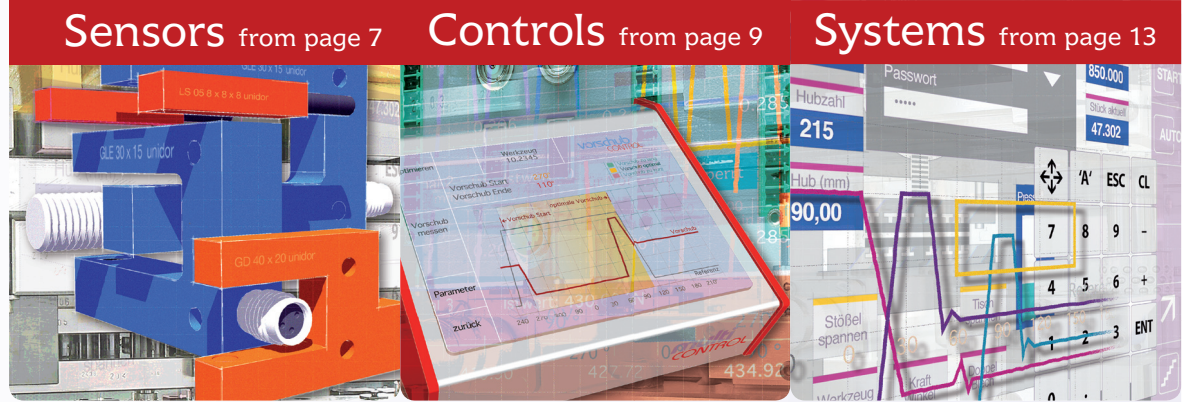

Visualise, measure, optimise, control, monitor – that is what our products are designed to do. And that is why we are a competent professional team.

## 3 product lines in 4 applications

The UNIDOR concept could not be described more simply: Sensors, controls and systems ensure optimum results in machines, in production, in the tool and in modernisation.

We can't do everything, but in the field of punching & forming we are professional and reliable partners. Your enthusiastic problem solvers for perfect production processes and the highest quality.

### 1 Sensors

unidor supplies a wide range of special sensors in different forms as the basis for exact visualisation, optimisation, measurement, controlling and monitoring of all punching and forming processes.

### 2 Controls

Controls are the classic inexpensive first step into professional visualisation and monitoring of different production processes in punching and forming technology. Controls are exactly geared to specific applications.

### 3 Systems

The "all in one" systems are universal devices that are prepared for a large number of applications and can be tailored to precisely meet your requirements – these today and others tomorrow.



With a completely new safety concept for our systems  
See pages 18 + 22 for more information



Sensors, controls and systems from *unidor* for perfect punching & forming for ...

## 1 Machine engineering

visualising, measuring, monitoring – special duties related to the punching and forming process expand every machine controller into a complete automation system.

The *unidor* products can be easily integrated as independent units into your control concept via standardised interfaces and thus enhance the functions of the machine. **Simply ideal for the whole of your machine engineering.**

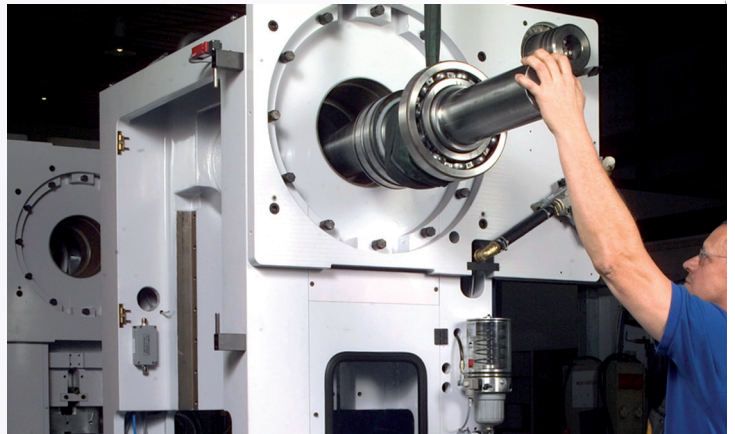

## 2 the production

High productivity and quality with the highest part complexity can no longer be achieved without suitable control and measuring systems to back up the production. *unidor* visualises, optimises, controls and monitors every production step, putting an end to speculation. Only objective, exact information and data help you to reliably control the production processes.

*unidor* products are designed to match all machines and tools. **Simple and basic machine retrofitting is thus possible at any time and anywhere.**

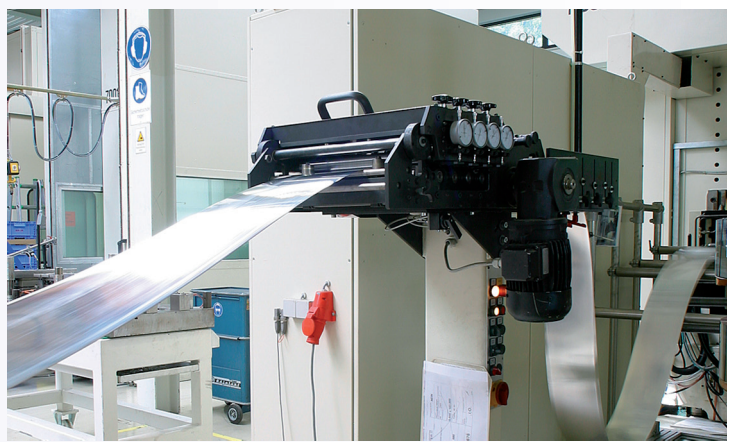

## 3 Tool construction

The closer to the process, the more precise the measurement and more exact the monitoring. That is why sensors have to be installed not only on the tool, but also in the tool. *unidor* supplies a wide **choice of special sensors** in a wide range of forms for many different measuring, control and safety functions in punching and forming.

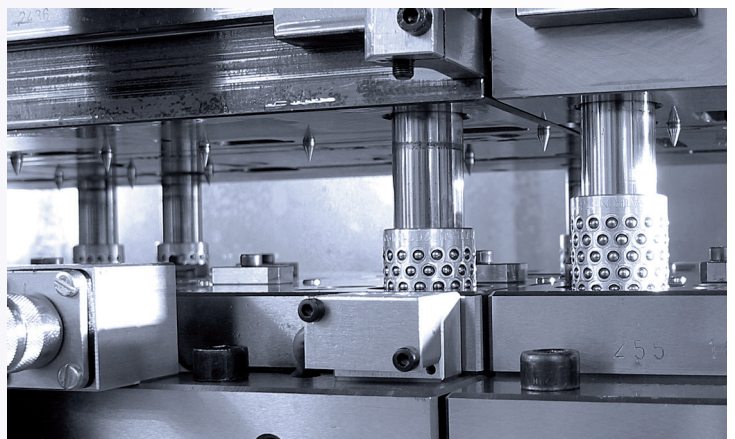

## 4 Machine modernisation

For punches and presses, a general overhaul of the machine is always an practical alternative.

For this, *unidor* offers a cost effective **complete upgrade package**: powerPRESS (S7-compatible controller, compact-PRESS) including all the necessary assembly, installation and commissioning services right up to the certified acceptance and handover.

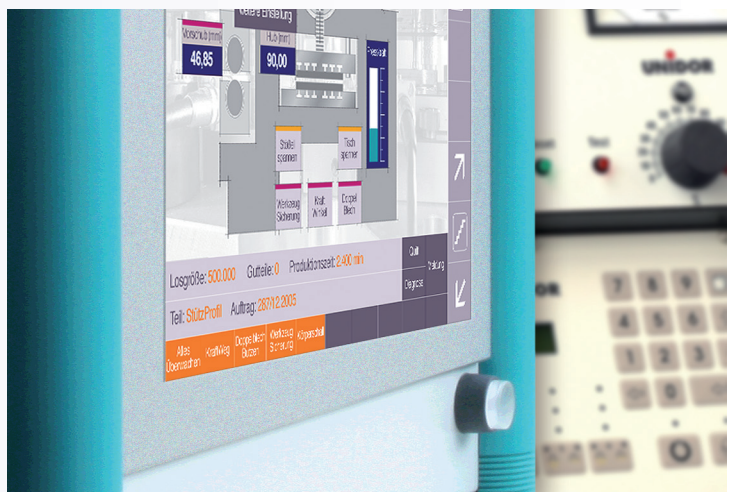



# Products for perfect punching & forming

6

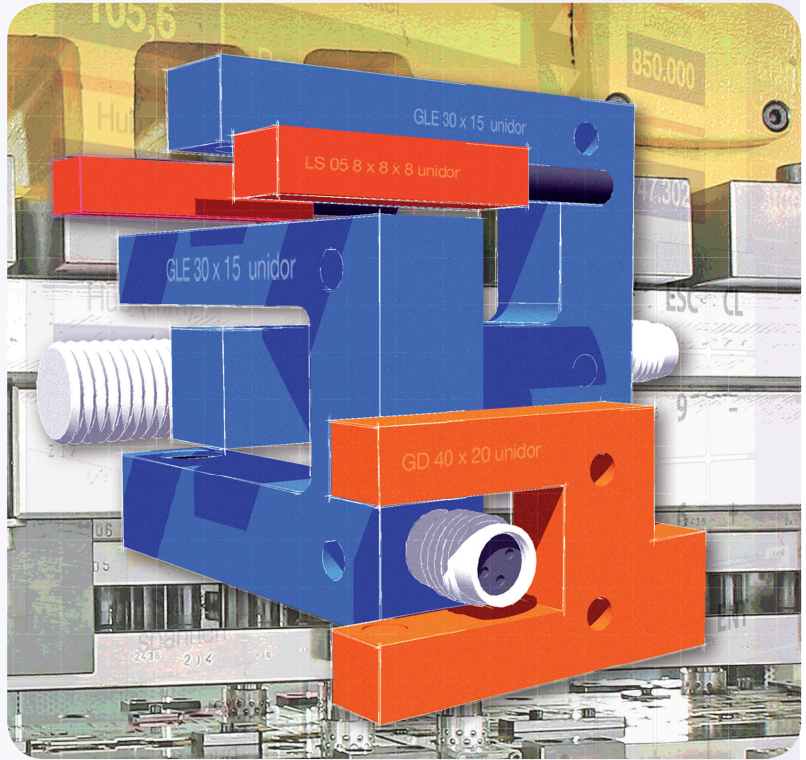

## more information ...

✉ [Brochure](#)

Sensors

[WEB](#)

[www.unidor.de](http://www.unidor.de)

☎ [Telephone](#) [eMail](#)

07231/3152 47

[michael.huschka@unidor.de](mailto:michael.huschka@unidor.de)

Michael Huschka

## Sensors

Right where it's happening, sensors transform pressure, sound, strokes, light or movement into digital or analog signals – the basis for exact visualisation, optimisation, measurement, control and monitoring of all punching and forming processes.

UNIDOR supplies a wide selection of special sensors in different forms, complete with the appropriate installation equipment.

### magicSENSOR

- wireless radio-controlled sensor

### analogSENSORS

- optical: yoke, rod, split

### digitalSENSORS

- Single-beam optical: yoke, rod, split
- Multi-beam optical: yoke, frame, ring
- Inductive
- Contact

### specialSENSORS

- Piezoelectric
- Acoustic
- Eddy current
- Colour detection



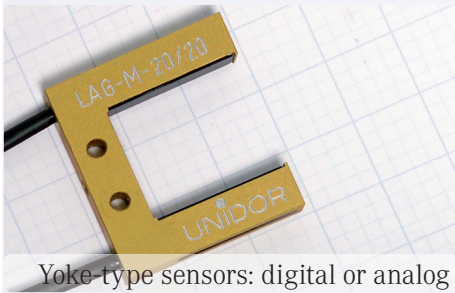

Yoke-type sensors: digital or analog



Rod sensors, inductive

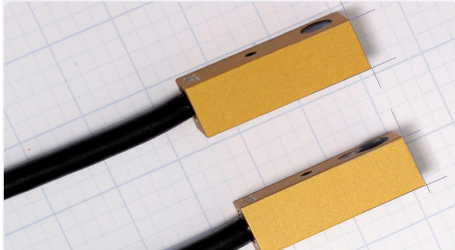

Sensors: split, digital or analog

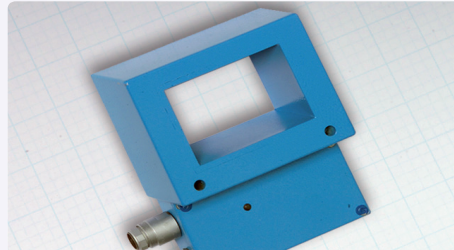

Frame-type sensors: inductive, digital



Rod sensors: analog

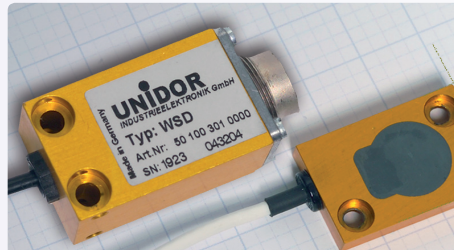

Eddy current sensors: analog

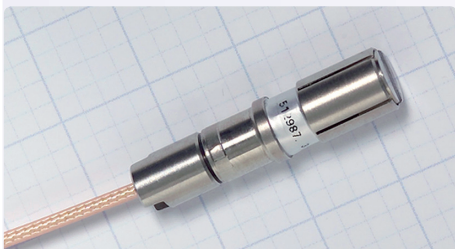

Piezoelectric sensors: rod form



Piezoelectric sensors: ring form



Special sensors: colour detection



Special sensor: acoustic

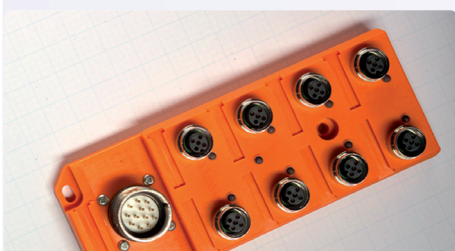

Die, measuring and I/O boxes



Rotary encoders, absolute

## 1 Sensors

We have the optimum sensor for every application. A few examples from our product range.

## 2 Boxes

As a rule, different numbers of sensors are installed on the machine and in the die. Distributor boxes have proved to be highly effective for quick and simple electrical installation. They are the sturdy interface between the sensors and the evaluation systems. Depending on the application and function of the sensors, we generally distinguish between:

### Die Box

For connection of up to 8 digital sensors (signal transmitters), PNP or NPN switching

### Measuring box

For connection of up to 8 analog sensors (signal transmitters) with integral 8-way analog measuring amplifier

### I/O box

For the I/O periphery with signal state LEDs. These boxes are supplied ready configured

## 3 Rotary encoders

During punching & forming, everything moves in one stroke, periodically in 360 angle degrees. Rotary absolute encoders are the optimum, high-precision position sensors for such applications.



# Products for perfect punching & forming

8

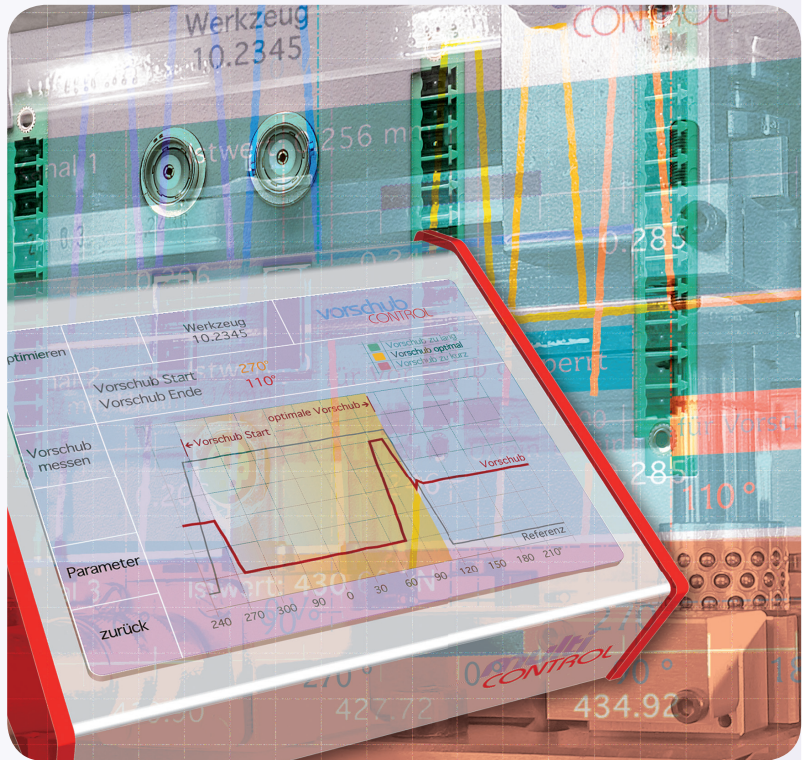

## more information ...

✉ Brochure

multiControl

WEB

www.unidor.de

☎ @Telephone|eMail

07231/3152 55

stefan.fraenkle@unidor.de

Stefan Fränkle

## Controls

Controls are the classic and inexpensive first step into the professional visualisation and monitoring of different production processes in punching and forming technology. Controls are not universal devices – they are tuned quite specifically to specific applications. No matter which control you choose, simply connect up, set and use.

We always supply the controls as ready-to-install functional packages with all the necessary accessories such as sensors, boxes and cables.

### multiCONTROL

- Infeed control
- Slug control (lamination monitoring)
- Die protection
- Press force monitoring
- BDC measurement

### smartoilCONTROL

- Variable coil width
- Oil medium changeover
- Zone lubrication

↑ the product



## 1 multiCONTROL

All currently available controls are supplied in a uniform design with identical hardware. These controls function without incremental encoder and are therefore particularly easy to install. Each control is available individually or as several controls combined in one housing:

### → infeedCONTROL

The optimised, controlled infeed provides more stroke, thus saving a great deal of money and improving the product quality.

### → laminationCONTROL

The lamination control or slug control detects even the slightest changes in strip thickness caused by slugs or clinging punching waste via envelope monitoring.

### → Die protection

Monitors the material transport and the end positions in the die.

### → Press force monitoring

Monitors the press force during forming by means of an envelope curve and thus detects even the slightest deviations in the force cycle.

### → BDC measurement

The closing of the die is exactly monitored and measured.

## 2 smartoilCONTROL

Oil lubrication of die and coil is crucial in punching and forming technology.

smartoilCONTROL moss 8000 stands for a completely new spray technology and ensures not only minimum oil consumption, but also an extremely consistent oil application. For the first time smartoilCONTROL offers a revolutionary **oil medium changeover** with automated residue cleaning.

The highly efficient **zone lubrication** is a further highlight, with only the zones relevant to the punching and forming process being lubricated.

We supply smartoilCONTROL for coil widths from 70 to 700 mm, and optionally in a one-track or two-track variant for single and double coil feed. The OPC interface permits simple communication with all automation systems.

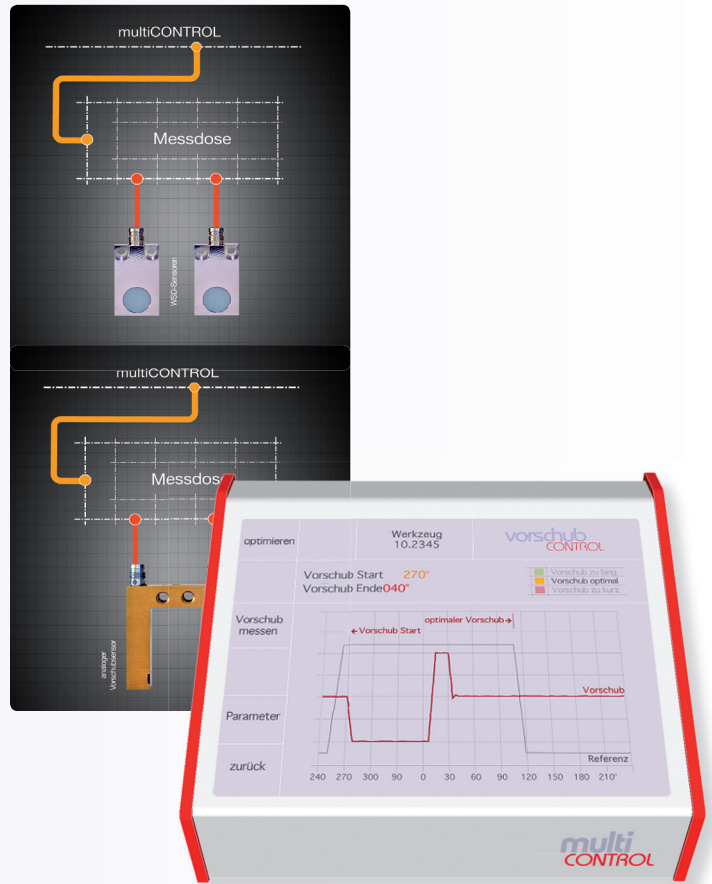

multiCONTROL design with a chart for feed optimisation

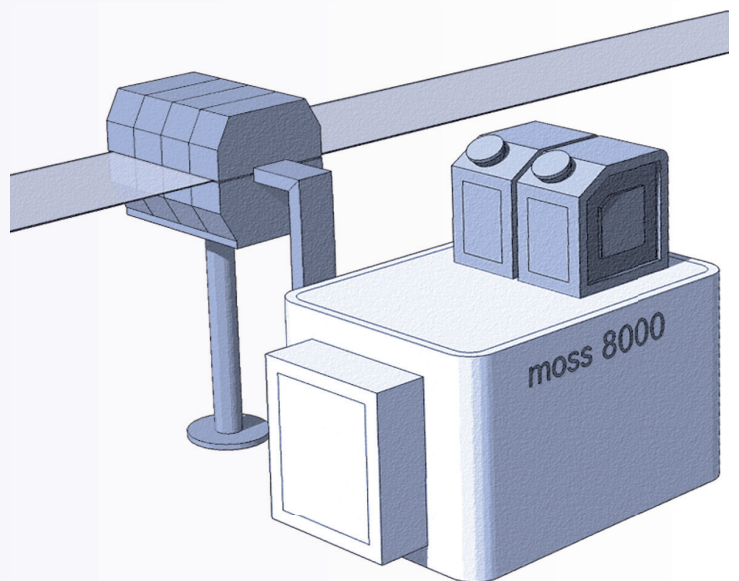

smartoilCONTROL moss 8000 with spray chambers, oil tanks, pump and control unit



# simply configure your controls individually

10

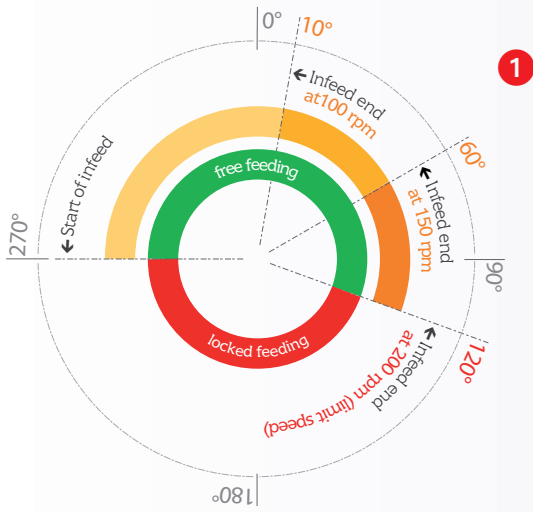

1

## → infeedCONTROL

As a rule, infeeds are set from “feel” and therefore frequently with a large safety margin. Up to **30% higher rotational speeds** are thus quickly wasted. Develop this enormous rationalisation potential through optimised infeed control.

The infeed control visualises for the first time the relationship between infeed and turn angle. The exact sequence of the stroke/infeed can thus be recognised and the “buffer” between the current infeed and an optimised infeed is quickly identified. Productivity reserves you can easily use with the infeed control without risking the safety of the machine or die.

more rotary speed, more production  
a realistic calculation

Basis: one machine hour 280 €

Rotary speed 1	180 rpm
results	10 800 units/hour
or	86 400 units/shift
cost per unit	2,593 Cent

Rotary speed 2	250 rpm
results	15 000 units/hour
or	120 000 units/shift
cost per unit	1,867 Cent

Balance

180 rpm = 2,593    86 400  
 250 rpm = 1,867    120 000

results    0,726 x 33 600

**saved = 244 € per shift**  
**or per week and machine**  
**2 200.-€, That's good. Isn't it?**

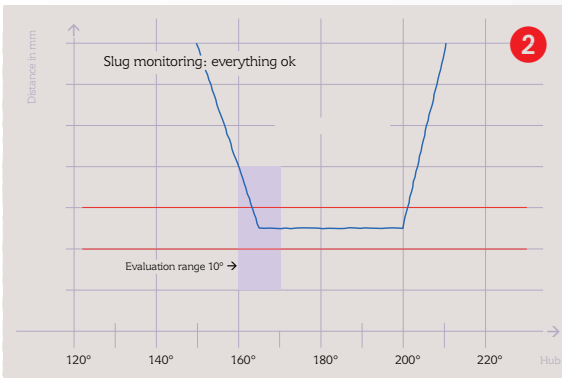

2

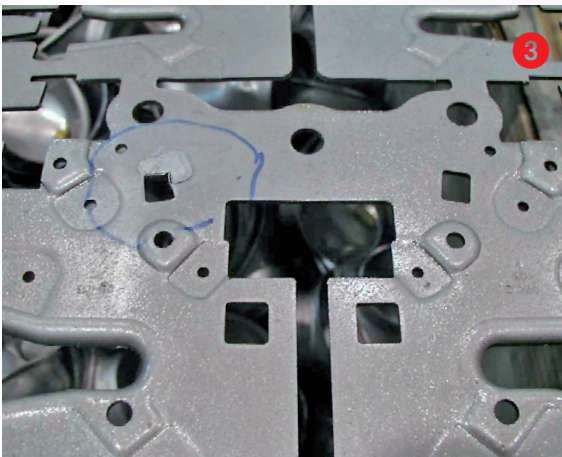

3



4

1 Circle diagram of the optimised infeed control

## → Lamination or slug control

For monitoring *slugs* or *clinging waste* in the die or on the material.

In punching and forming technology, slugs are a problem that cannot be eliminated. Slugs reduce the quality through faulty parts and can lead to serious die damage.

Even with the highest press forces, the slug control detects even the slightest **slug** during the production process, even with **double strip**. A detected slug triggers a fault signal that leads to a machine stop or the rejection of a faulty blank.

All that is needed for the multiCONTROL slug control is the installation of an eddy current sensor on the die. It really couldn't be easier.

2 Operating curve without slug

3 Slug impression in the material

4 Operating curve with slug. The multiCONTROL triggers a fault signal

↑ the details

↑ the details



## → BDC measurement

Precise measurement of the insertion depth and monitoring of the correct closing of the die.

The bottom dead centre (BDC) position is critical when the insertion depth for embossing and design fracture points and the exact closing of the die are important.

Changes in the machine operating temperature can lead to significant changes in the insertion depth and hence to considerable fluctuations in quality of the formed products. BDC measurement and monitoring of the insertion depth are therefore expedient and necessary wherever precise insertion depths are required.

The multiCONTROL outputs a fault signal if the set value is not reached or is exceeded.

All that is needed for the multiCONTROL BDC measurement is the installation of an eddy current sensor on the die.

- 1 Design fracture point of a carpet knife
- 2 Design fracture point on a drinks can lid
- 3 Operating curve for BDC measurement

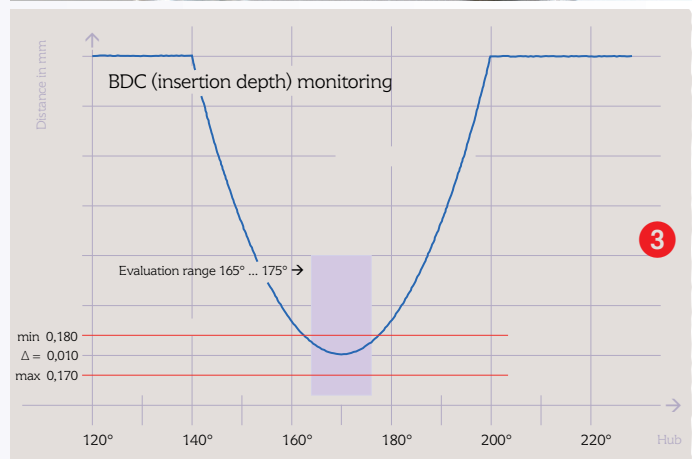
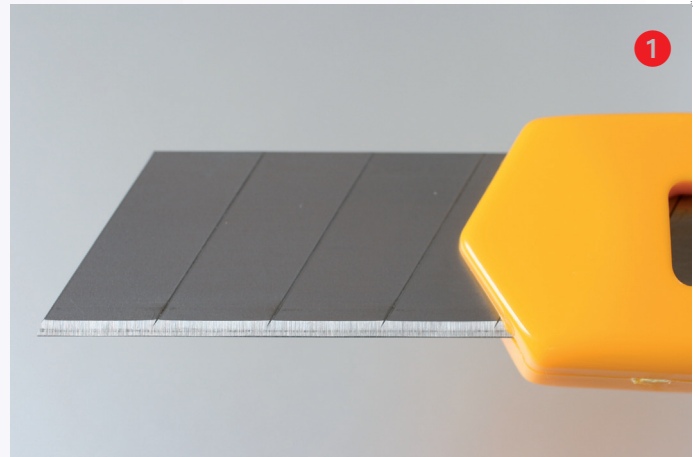

## → Press force monitoring

Monitors the press force during punching & forming and thus detects even the slightest fluctuations in the force curve.

The press force is the most important parameter in all punching and forming processes. A change in the press force during production is always an indication of danger or at least of impending problems.

If the min/max limits are exceeded, the multiCONTROL outputs a fault signal.

All that is needed for the multiCONTROL press force monitoring is the installation of an eddy current sensor on the die.

- 4 Press force curve with min/max limits

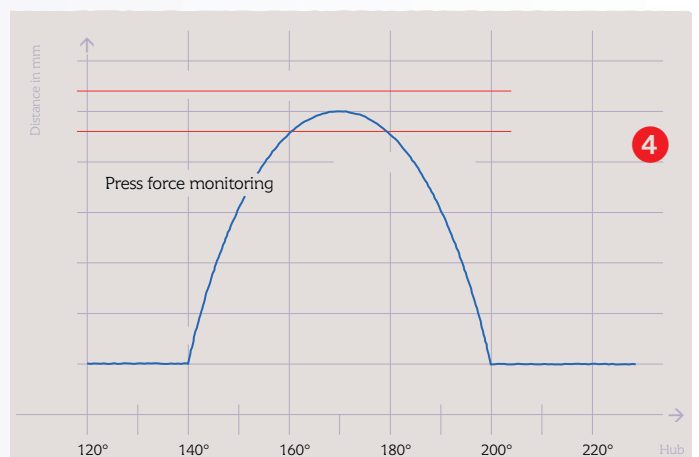



# Products for perfect punching & forming

12

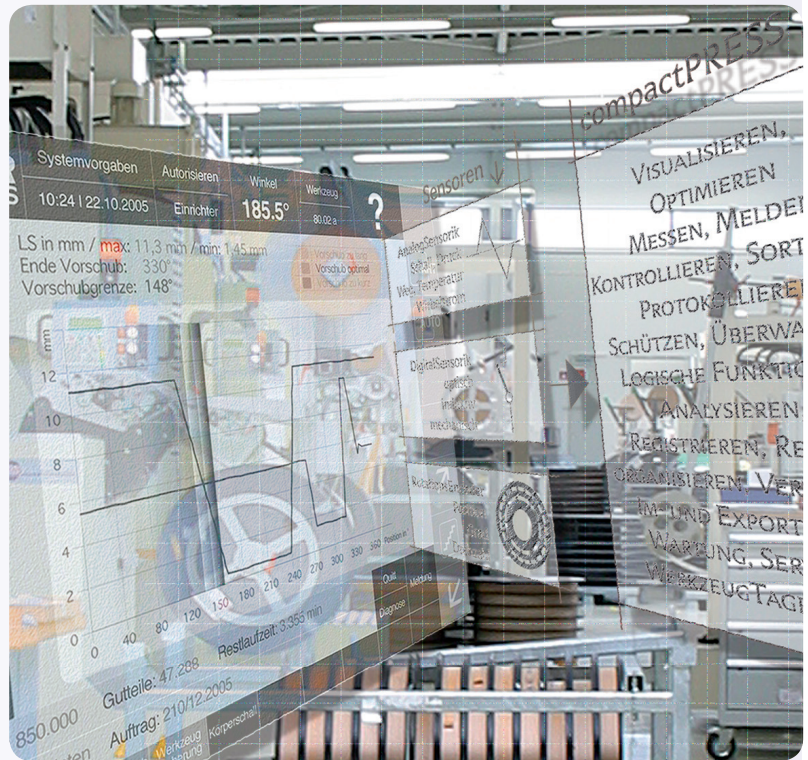

## more information ...

✉ Brochure

compactPRESS

WEB

www.unidor.de

☎ @Telephone|Mail

07231/3152 26

ullrich.hauser@unidor.de

Ullrich Hauser

## Systems

The “all in one” process systems are universal devices that are prepared for a large number of applications and can be structured to meet your requirements precisely – these today and others tomorrow.

Systems that meet different demands at the same time, that exactly supply the data and information that help you to achieve optimum results at all times.

### powerPRESS

- S7-compatible PLC
- compactPRESS starline

### compactPRESS

- compactPRESS ecoline
- compactPRESS starline



## 1 compactPRESS

Whenever you wish to optimise your production processes and ensure total monitoring of your dies, compactPRESS is first choice as stand-alone **measuring and control system**. compactPRESS can be quickly and easily retrofitted on any machine and any controller, whether conventional or PLC.

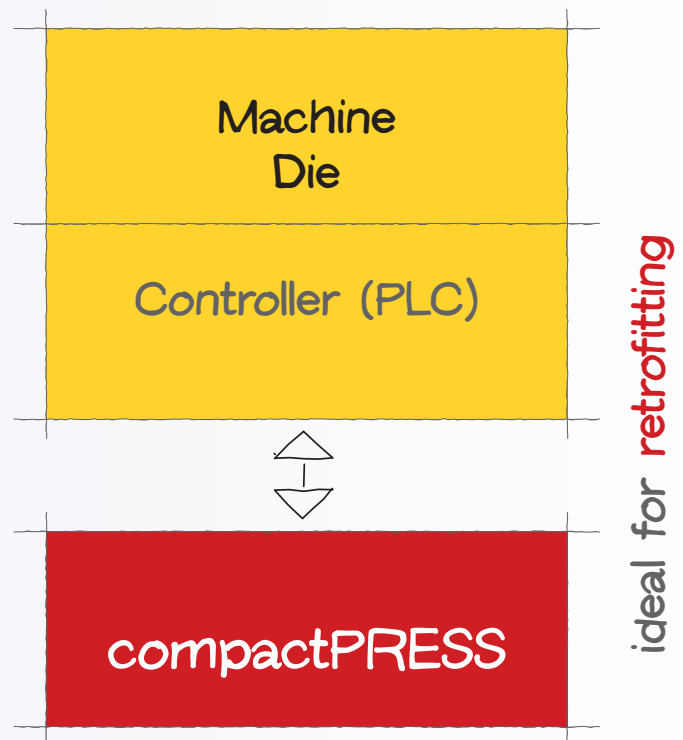

## 2 powerPRESS

powerPRESS automates the complete machine: From the PLC (S7) through to the high-speed process monitoring with compactPRESS. The complete automation solution from a single source, the technical and economical alternative.

powerPRESS is the ideal automation system for OEMs (machine and plant engineering) and for all companies machine who refurbish machines.

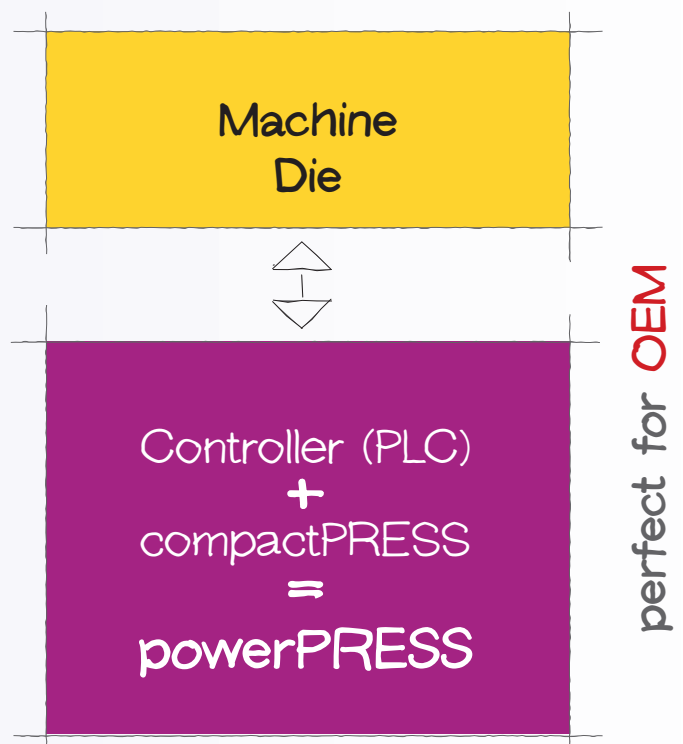



# one compactPRESS for an infinite range of applications

14

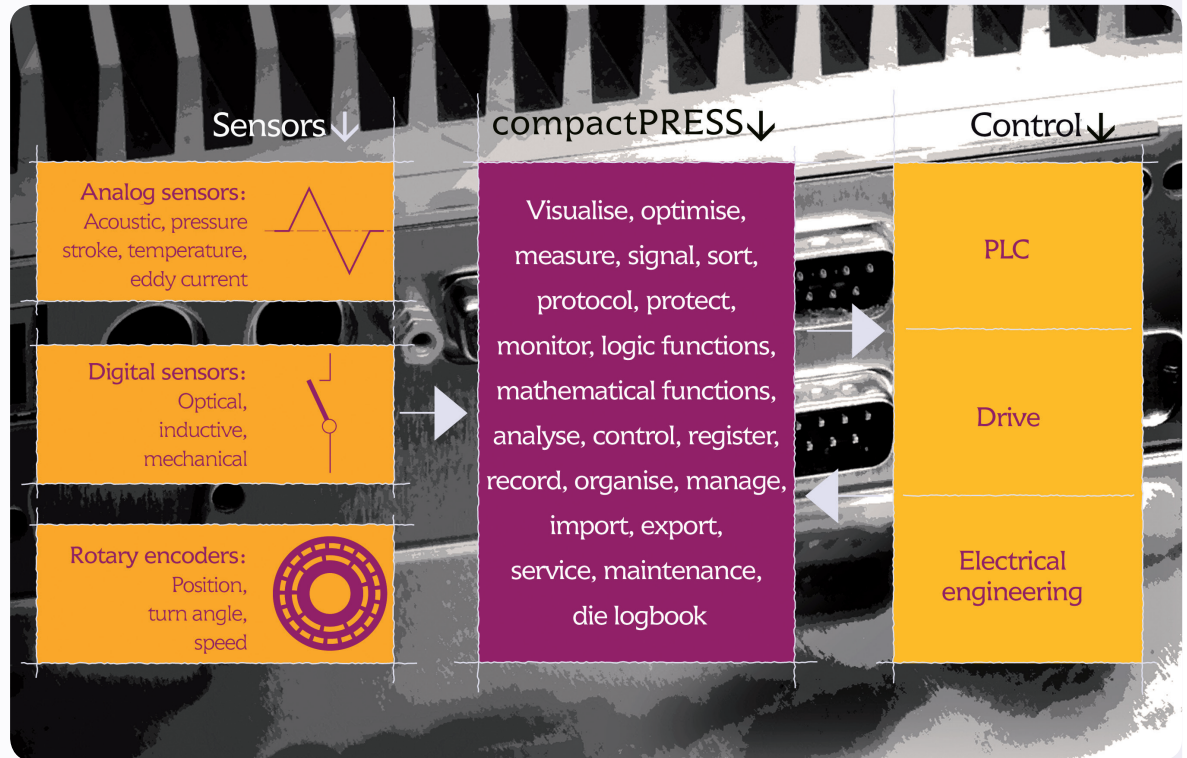

## more information ...

✉ [Bochure](#)  
compactPRESS

WEB  
[www.unidor.de](http://www.unidor.de)

☎ [Telephone](#) | [Mail](#)  
07231/3152 26

[ullrich.hauser@unidor.de](mailto:ullrich.hauser@unidor.de)  
Ullrich Hauser

## System: compactPRESS

The different controls ensure the wide range of functions and universality of compactPRESS. compactPRESS displays, signals and monitors with the greatest precision everything that goes to make up an optimum and continuous production process.

compactPRESS – the all-round insurance for machines and dies.

### *BasisControl*

- *Management: Die, messages, colour, ...*
- *System setting, dual help system*

### *DigitalControl*

- *Rotary cam switch, die monitor, counter, positioning*

### *AnalogControl*

- *Force angle, lamination, acoustic*

### *MeasuringControl*

- *Analog infeed optimisation*
- *Strip width, strip thickness, parts*
- *Dimension check*

### *ProcessControl*

- *TDC stop, stroke rate adjustment, stroke rate table*
- *Sorting, external die changing*

### *ManagementControl*

- *Data import, data export, data archiving*
- *Tool logbook, maintenance & repair*



# the system: compactPRESS

15

Your dies are too important and too valuable to simply leave them at the mercy of the machine and its control system. compactPRESS looks after and protects your dies, and at the same time ensures an optimised and controlled production process.

Treat yourself to compactPRESS for better products and lower costs, for more precision and less scrap.

compactPRESS fits in everywhere and anywhere. Retrofitting is quick and simple, and interferes with neither your machine nor the control system. We supply you with everything that compactPRESS needs - including the installation and service.

## → that is compactPRESS

→ compactPRESS is your all-round assistant for practically everything, a professional for measuring, controlling and rationalising punching and forming. Ultrafast right up to the highest stroke rates,

→ compactPRESS protects your machines and dies, ensures regular maintenance and service, manages, monitors and archives all production and quality data,

→ compactPRESS offers simple touch-pad operation that everyone understands from the beginning. Icons instead of buttons guide and inform the operator in every situation. It was never easier to know what's going on,

→ compactPRESS is based on an extremely reliable IPC. The best solution for continuous operation under the rough conditions near the machine,

→ compactPRESS displays what is going on in the machine and die directly at the machine or via a central control panel. No matter where your machine is producing, you have everything in your sights at all times,

→ compactPRESS understands all analog or digital sensors and combines them as you require - functionally, logically or mathematically,

→ compactPRESS as a stand-alone system preferably for retrofitting or as a PLC sub-system of a controller as original equipment,

→ compactPRESS increases the availability of machine and die and ensures increased availability of data, particularly during critical production processes with difficult materials.

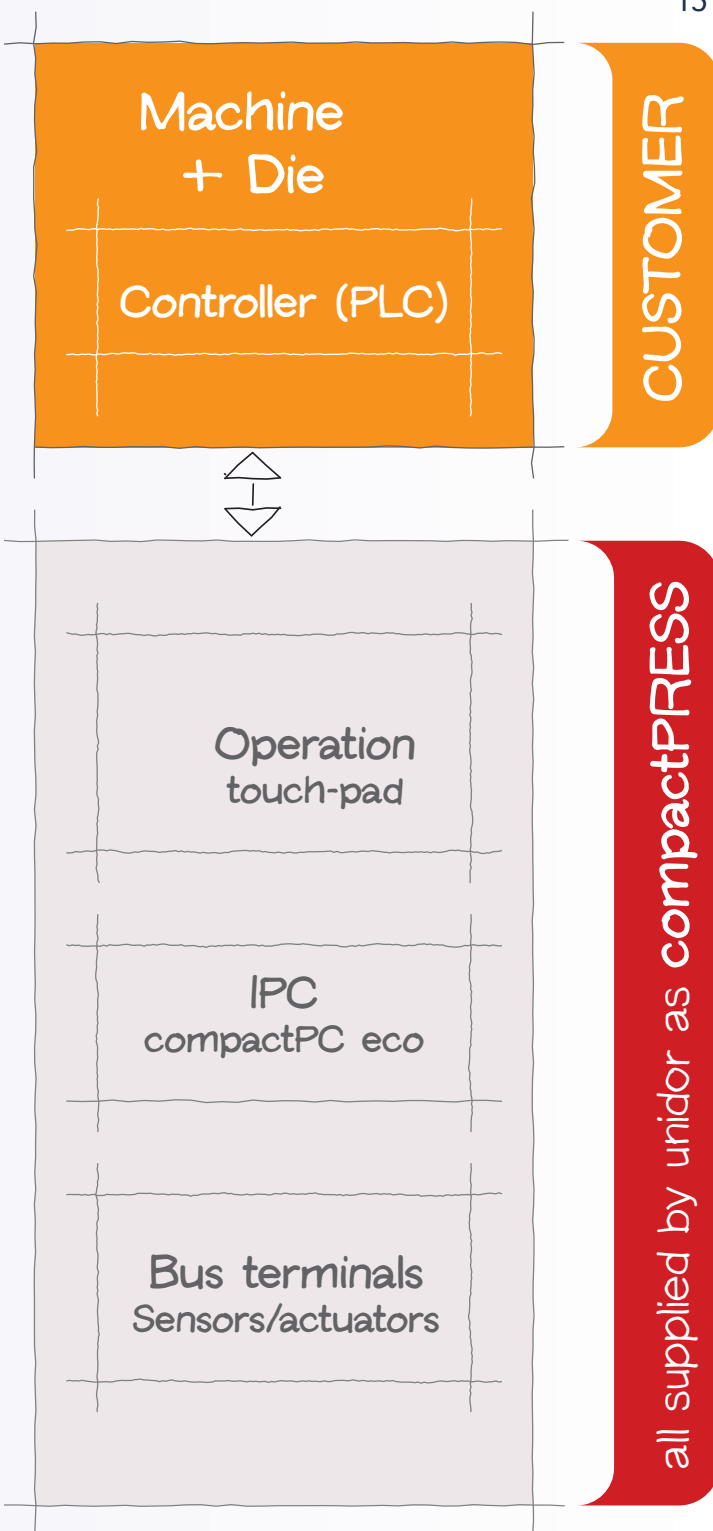
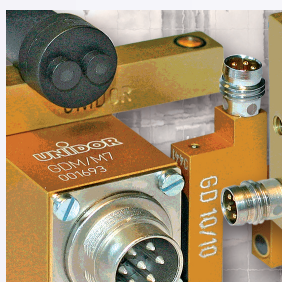

↑ the details

↑ the details

# with Controls, compactPRESS becomes a multi-talent

16

## 1 Nothing goes without Controls

The extremely flexible controls determine the immense variety of functions offered by compactPRESS. Together with the matching digital, analog and special sensors, they comprehensively visualise, measure, optimise, control and monitor the production process of punching and forming.

Controls are actuating and functional elements, special 'tools' for a wide range of tasks and applications: They show exactly what is going on, ensure the transparency in production, optimise the manufacturing, guarantee a constant high quality and document all the important process data. They help you meet your customers' growing demands for greater complexity, precision, productivity and quality.

## 1 basicCONTROLS

The heart of every compactPRESS is the integrated smartPLC. It links the controls, coordinates the timing and manages all the process. The real-time core guarantees correct performance of all time-relevant functions.

## 2 digitalCONTROLS

This group comprises all the controls for digital signal processing. Signal transmitters are all commercially available digital sensors.

## 3 analogCONTROLS

This group comprises all the controls for analog signal processing. Analog sensors are the ideal signal transmitters here.

## 4 measuringCONTROLS

This group comprises all the controls that continuously measure and control the material and the production process. Important controls for complex products, optimisation of the quality and its comprehensive QA documentation.

## 5 processCONTROLS

Intelligent controls for automatic product sorting and selection.

## 6 managementCONTROLS

Controls that manage data, information and actions: Die log-book, maintenance organisation, QA reports, import and export of data, etc.

## 7 oemCONTROLS

Controls that act as intelligent interfaces, coordinating communication with other automation systems.

The screen views of the various controls opposite show a few examples of applications.

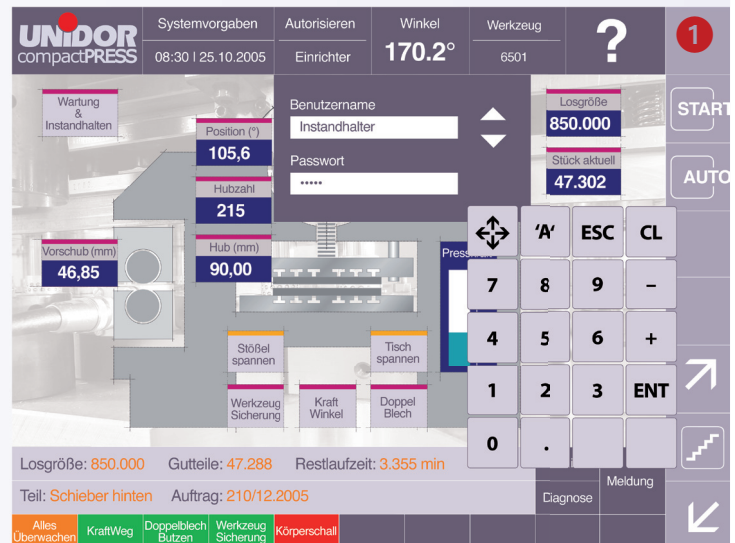

1 Basic mask with numeric keypad for input of numerical values

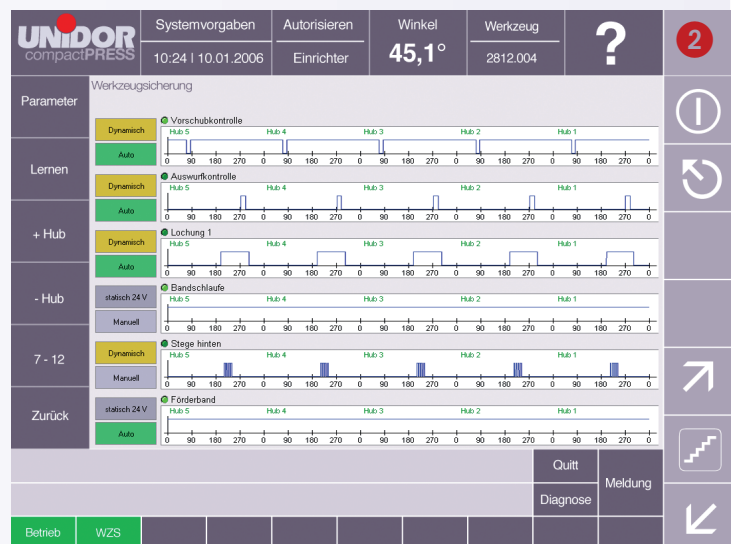

2 digitalControl: for die protection

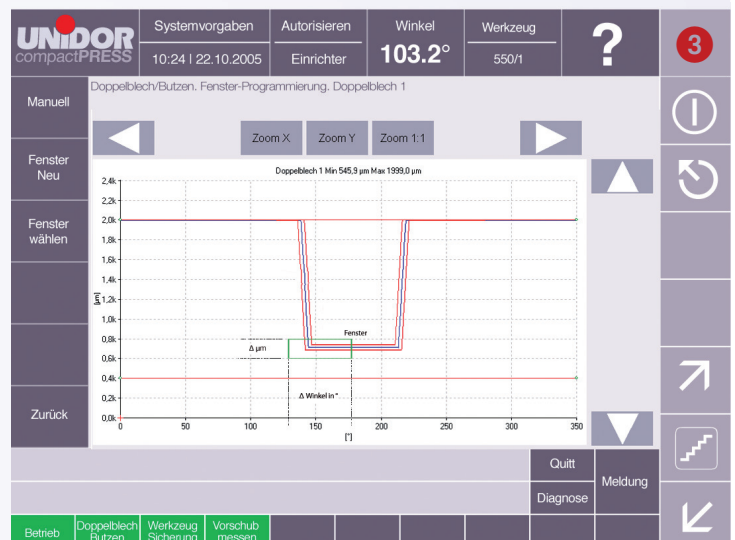

3 analogControl: Lamination monitoring



# the system: compactPRESS

17

As important as the controls are for universal application of compactPRESS, their operation is equally as important.

## → the “anyone can” operation

The times when dozens of control buttons were scattered more or less logically around the front panel have gone.

The modern touch-pad operation of compactPRESS with its process-related, task-specific icons permits easily understood, intuitive (self-explanatory) and logical operation.

The modern visualisation guides the operator from the overall machine mask to the operating detail and back again. Freed from confusing visual information, it always shows only the elements required for each particular operating step. No matter whether you touch forwards or back, whether you start a function or enter production values, the overview is never lost.

Furthermore, compactPRESS checks your inputs validity and corrects them automatically, if necessary.

## → always in the right language

compactPRESS is multilingual – every operator can select the language he understands.

## → help whenever you need it

Should you ever get into a situation where you don't know what to do – ask compactPRESS. Just press the ? button and you immediately receive precise, context-related help.



1 Whether you are activating a particular function, or ...

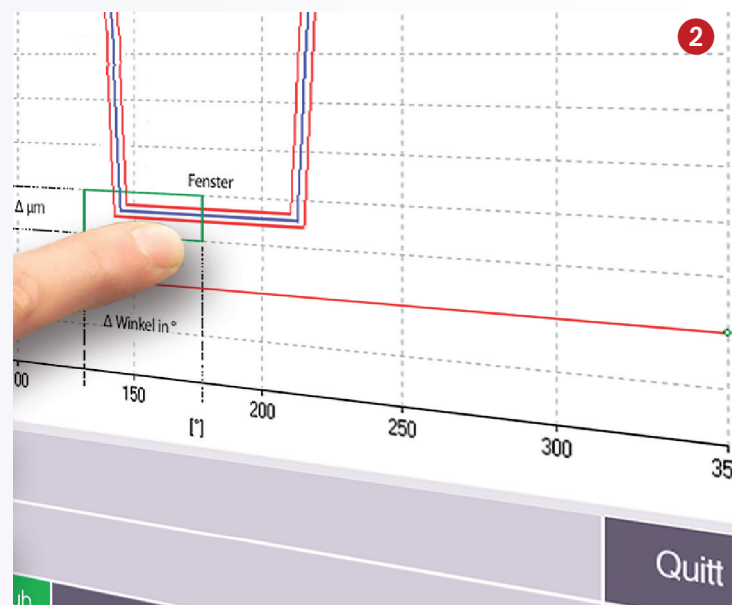

2 moving control windows, everything is controlled by touch.

# Reliable hardware. Reliable software. 100% availability.

18

Reliable hardware. Reliable software. This two-fold safety concept of compactPRESS ensures the highest system availability and the trouble-free function of its controls.

## → Safety first

Data security and constant functional availability have the highest priority with us, guaranteed by the compactPC|eco together with our **CRASHSTOP** safety technology. The result is a very safe computer system for our compactPRESS.

*CRASHSTOP efficiently eliminates any weaknesses in the hardware and software through a whole package of effective measures:*

- data backup via driveless flash memory
- separate flash memory for programs (read mode only) and for data (write/read mode)
- comfortable automatic backup management through flash partitioning
- redundant, fault-tolerant data storage management (three stage data storage engine)
- in the unlikely event of a software error, compactPRESS automatically restarts the operating system and the programs via internal self-repair mechanisms
- fast system start thanks to flash technology
- automatic update service via USB stick
- reduced data memory accesses ensure higher speed and flash-conserving storage operations
- the intelligent PowerControl always updates all the data, independently of the operating voltage: *Reading on starting and writing when the operating voltage is switched off.* In the event of a spontaneous power failure, all changed data is automatically written to the flash and thus reliably saved.

Whenever compactPRESS is in operation, you have to be able to rely on it.



↑ the details

↑ the details



# the system: compactPRESS

The multi-talent compactPRESS demonstrates its excellent integration capabilities particularly in the retrofitting of new or old machines. The upgrading of older machines with compactPRESS in particular results in old punches and presses looking as good as new.

## → simple retrofitting

Important for the simple retrofitting of compactPRESS is minimum intervention in the existing machine controller. As a bus interface is normally not possible, communication between the compactPRESS and controller takes place via a small number of I/O terminals that are quickly installed.

Logic links, where necessary, are easily implemented via the internal smartPLC of the compactPRESS so that intervention in the existing control system (PLC program) can often be eliminated. compactPRESS is ideal for retrofitting and adaptable to all machines and dies.

## 1 compactPRESSecoline

*ecoline* is the ideal first step into the compactPRESS technology with touchDisplay and embedded PC.

The link between sensors/actuators and *ecoline* is effected via EtherCAT terminals in the Ethernet. EtherCAT ensures the very high-speed digital and analog I/O signal transport as the basis for highly dynamic process handling.

The number of I/O terminals, i.e. the number of sensors and actuators, can be scaled as required.

## 2 compactPRESSstarline

compactPRESS*starline* is the high-end variant for a broad range of ultra-high speed applications. *starline* is touchCommand, IPC and fast I/O board with installation box.

The combination of fast I/O board with IBOX controls

Analog Input	16 channels, each 12 bit
Analog Output	4 channels, 0 – 10 VDC
Digital Input	32 ultra-high speed
Digital Output	32
SSI	4
CAN open	1
RS 485	1

The IBOX ensures simple connection of all I/Os via 1.5 mm<sup>2</sup> terminals plugs. Cascading of the IBOX for even more I/Os is possible.

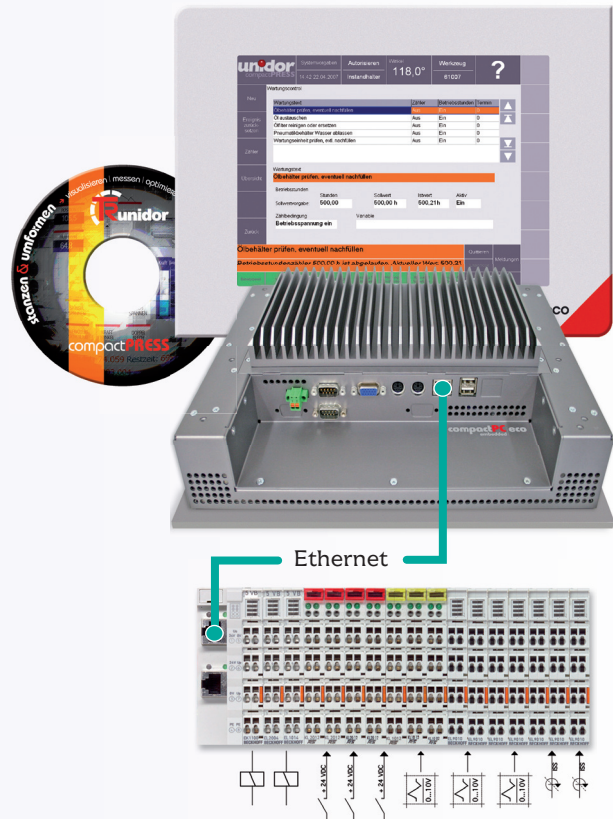

compactPRESS as ecoline

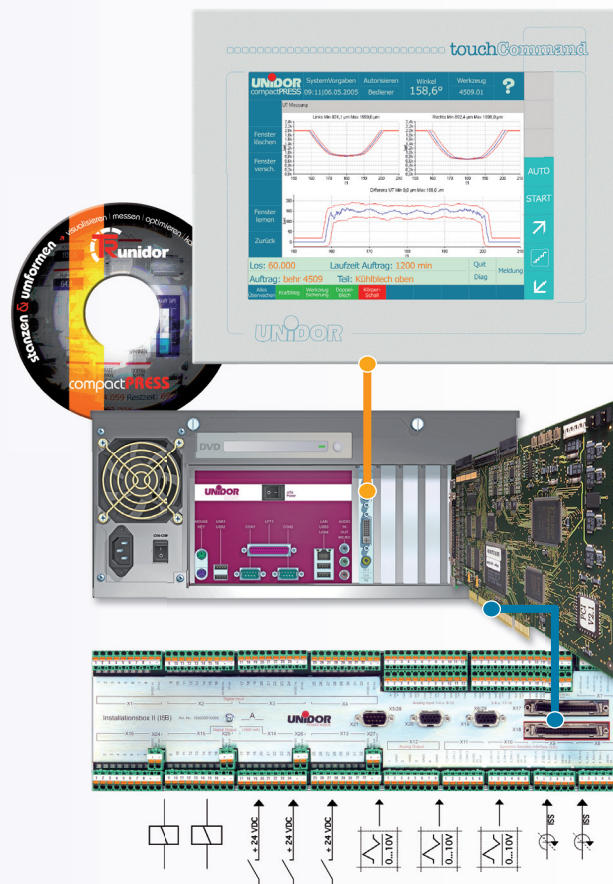

compactPRESS as starline

# the complete machine automation

20

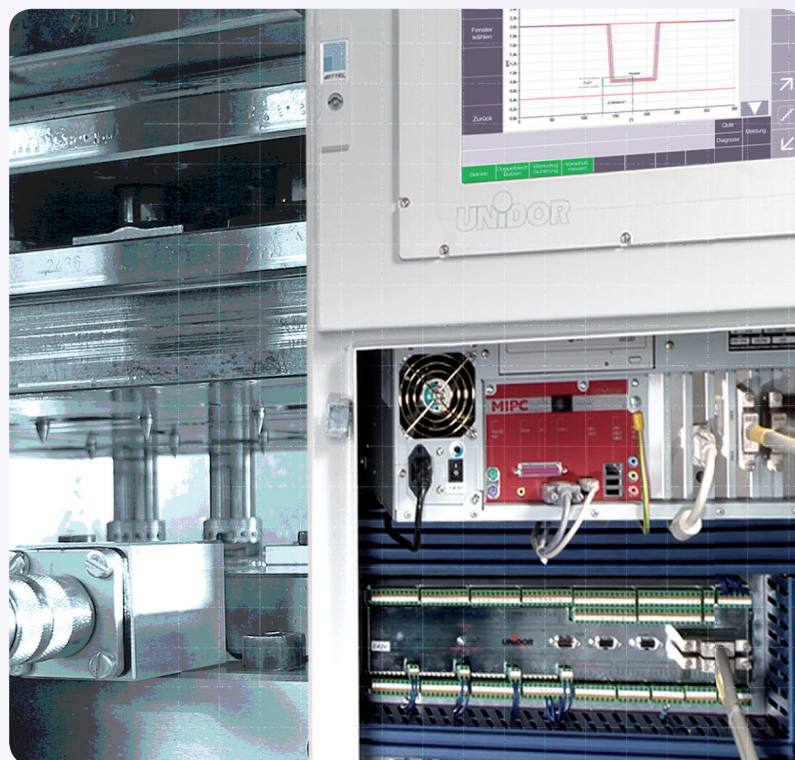

## more information ...

✉ [Brochure](#)

compactPRESS

[WEB](#)

[www.unidor.de](http://www.unidor.de)

☎ [Telephone](#) | [Mail](#)

07231/3152 26

[ullrich.hauser@unidor.de](mailto:ullrich.hauser@unidor.de)

Ullrich Hauser

## System: powerPRESS

powerPRESS combines the control system with the modern process monitoring system, compactPRESS to form a complete machine automation concept and combines your machine and control components with our experience in process technology, opening up totally new technical and marketing perspectives.



the product



## → powerPRESS

Not only is compactPRESS suited to retrofitting, it is perfectly suited to original equipment.

powerPRESS combines the operation, control (PLC) and drive of machines with the measuring and quality technology of dies to form a complete machine automation solution.

Such a perfectly balanced automation of punches and presses is not only a technical trendsetter, but also economically highly attractive.

Everything comes together in the compactPRESS *all-in-one* automation concept: The user-friendly touch-display operation, the sturdy IPC and decentral easy-to-install I/O terminals, powerPRESS takes care of the whole machine and die - everything from a single source.

Nevertheless, the *know-how* of the control system and the whole automation of the machine remain under your control. You can still respond quickly and selectively to the needs of your customers and the market - independently of us.

## → powerPRESS for modernisation

powerPRESS is the first choice for modernisation, because the future oriented automation of punches and presses demands not only a modern control concept for the machine, but also extensive monitoring of the production process. compactPRESS is both.

## → powerPRESS and more

For the communication between PLC and compactPRESS, we supply a range of ready-to-use PLC data modules that you can quickly and easily integrate into your programs.

From the PLC planning through to the complete control cabinet, we supply a service package for powerPRESS individually coordinated with you.

And of course our experts are always at your disposal with help and advice - from the initial installation through to the after-sales service.

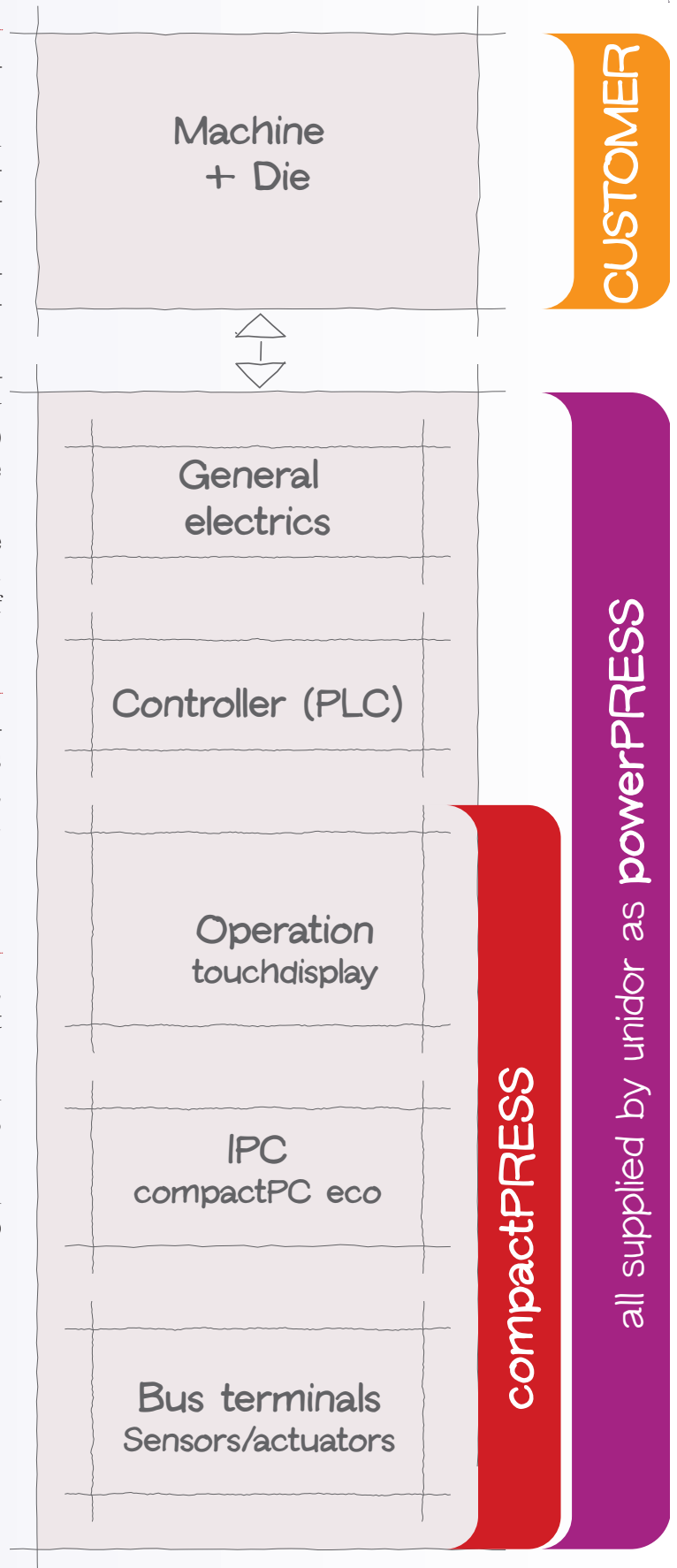

the first IPC **without** hard disc - for the highest security demands

22



## compactPC|eco

The hard disc is out in the PC technology of the future. Secure computers have no drives but almost 100% availability. Our compactPC|eco is practical proof of this.

### more information ...

✉ Brochure

compactPC|eco

WEB

www.unidor.de

☎@ Telephone|eMail

07231/3152 41

peter.schmidhaeussler@unidor.de

Peter Schmidhäußler

### Technical data: PC

Power	24 VDC ± 20% / 120 W
Housing	aluminium housing, front panel mounting, front panel IP 65
CPU	Celeron M, 1,3 GHz
Back Panel I/O	PS/2 keyboard, PS/2 mouse 2 x serial, VGA, 2 x USB, 2 x LAN
Network	Fast Ethernet 10/100 Mbps, RJ 45
Main memory	256 MB DDR RAM
Program flash	up to 2 GByte, Type II IDE
Data flash	up to 2 GByte, Type II IDE
Climate	0...45°C (operation), 5...90% non condensing
Test standards	EN 50081-2 / 50082-2 / 61000-4-2 61000-4-2 / 4-4 / 4-5 / 50140 / 50141
Installation dimensions	240 x 324 x 60 mm (H x W x D)

### Technical data: touchDisplay

Monitor	12" TFT-Display, IP 65
Touch	resistive
Pixels/pixel size	1024 x 768 (XGA) / 0,297 x 0,297 mm
Brightness/contrast	250 cd / 350:1
Vibration/impact	1,5/10...200 G/Hz / 50/20 G/ms
Climate	0...45 C° (operation) 20...85% relative humidity
Front dimensions	276 x 358 mm (H x W)

↑ the product



# the system hardware: compactPC|eco



Computers without mechanical drives are the key to the future. Flash instead of hard disc is the ideal decision, particularly for the industrial PC. The new flash generation together with our ingenious *crashSTOP|Technologie* opens up completely new security standards in technical PC application.

Put an end to production stoppages caused by dubious data losses, to hard disc problems and time-consuming reinstallation of defective operating systems.

## compactPC|eco

In view of the demand for maximum availability of our systems, we constantly employ the new secure PC technology completely **without mechanical drives and fans**. These PCs operate absolutely wear-free. Vibrations, impacts and blows are no problem for these computers any more. The compact aluminium housing of the compactPC|eco provides optimum protection for PC and touch display when used near the machine.



Installation is quick and easy – no matter whether in a control pendant, machine console or switch cabinet, there is always space for the compactPC|eco.

All connections are located on the rear of the housing for easy access.

The compactPC|eco is thus the ideal computer platform and the perfect hardware also **for your software applications**. The only correct decision when reliable, continuous and trouble-free operation is demanded.

## Flash – the new memory standard

The compactPC|eco has two flash slots: *Flash 1* is reserved for the operating system and applications programs, *Flash 2* for the data.



This splitting of the data has the advantage that the memory access can be organised differently: The secure, practically crash-free read mode for the program flash and write/read mode for the data. There is also a simple backup handling for the partitioning of the data flash.

The additional intelligent battery management system ensures automatic reading of the data when switching on and writing back of the data when the power supply is switched off. In the event of a spontaneous power failure, all changed data are automatically written to the flash and thus reliably saved.

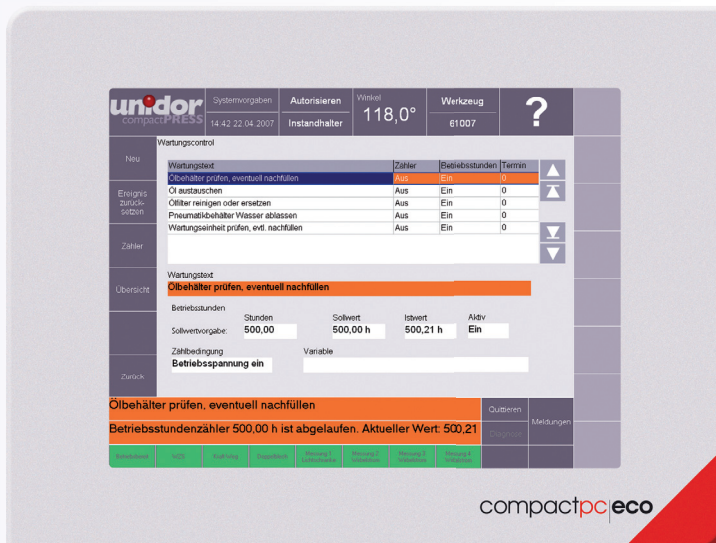

Front side with 12" TouchDisplay



Rear side with all the connections

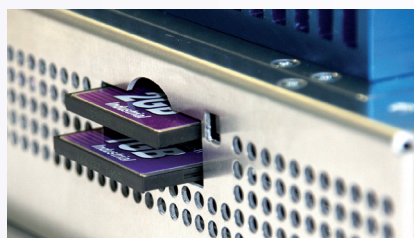

### practical memory organisation

		Access	Partition
flash 1	Operating system (xp-embedded) Application programs	read	none
flash 2	Data	read/write	possible

plug-in flash on the rear side

# Products for perfect punching & forming

24

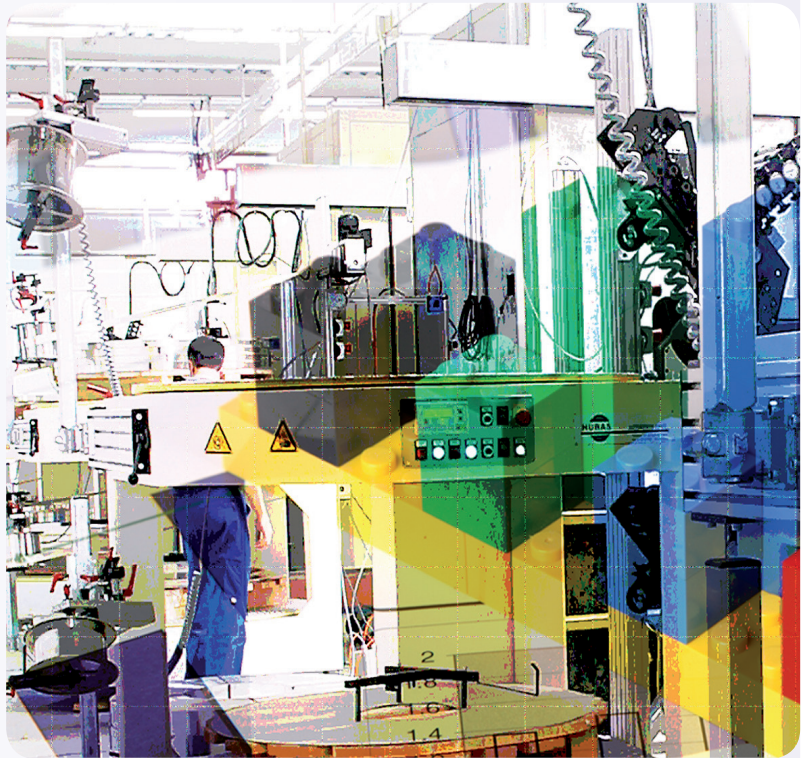

## more information ...

✉ [Brochure](#)

Brochure: Modernisation ...

WEB

[www.unidor.de](http://www.unidor.de)

☎ [Telephone](#) | [eMail](#)

07231/3152 42/33

[juergen.Kasper@unidor.de](mailto:juergen.Kasper@unidor.de)

Jürgen Kasper

## Modernisation

Renovation, general overhaul, modernisation – several names for the same objective: The complete renewal of punches and presses. *unidor* is the first choice here.

Presses and punches are durable machines that can bring top performance again with a new, modern automation system. So why think about buying a new machine when a huge amount of money can still be earned with the old machines.

Turning Old into New is therefore always a financially attractive alternative.

### Modernisation package

- Current machine status
- Expertise for electrical general overhaul
- Switch cabinet + control panel
- Controller: PLC S7 (as hardware or software)
- compactPRESS starline or ecoline
- General electrical equipment
- Installation
- Handover and acceptance with safety check
- Training



# the perfect machine modernisation

## 1 Status and expertise

We first determine the current status of the machine. In a subsequent expert meeting we then explain the various possibilities of a cost-effective modernisation.

In an expertise we describe all the applications and work processes with a detailed time schedule for the completion of the project.

The highest priority for a general overhaul is the shortest possible interruption in operation of the machine.

## 2 Implementation

We have vast experience in project management backed up by a team of highly qualified specialists to handle everything from the project planning, through punctual availability of all the new components, complete preassembly of the control cabinet, quick relocation on site right up to commissioning and the trial run of the machine. We have everything under control - nothing is left to chance.

## 3 Handover & operation

We take particular care in the handover of the machine to Maintenance or Production: The acceptance test, the proof of function and performance including a comprehensive operational check on the basis of the latest safety standards (BG, EN, etc.) are performed together with your authorised personnel. All the relevant processes and data are recorded in an acceptance certificate.

Training courses, long-term service agreements and a spare part package are all part and parcel of the modernisation of your machine.

powerPress (more details from page 20) is the first choice for modernisations, all you need for the electrical equipment is contained in this complete automation package.

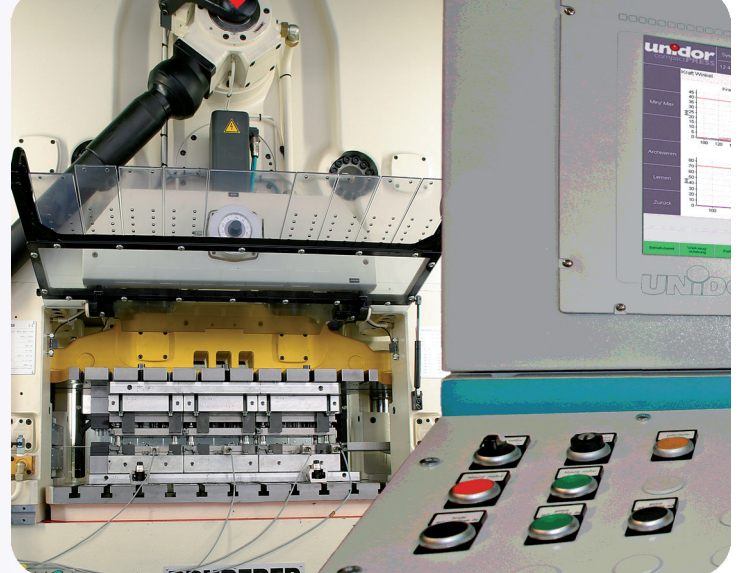
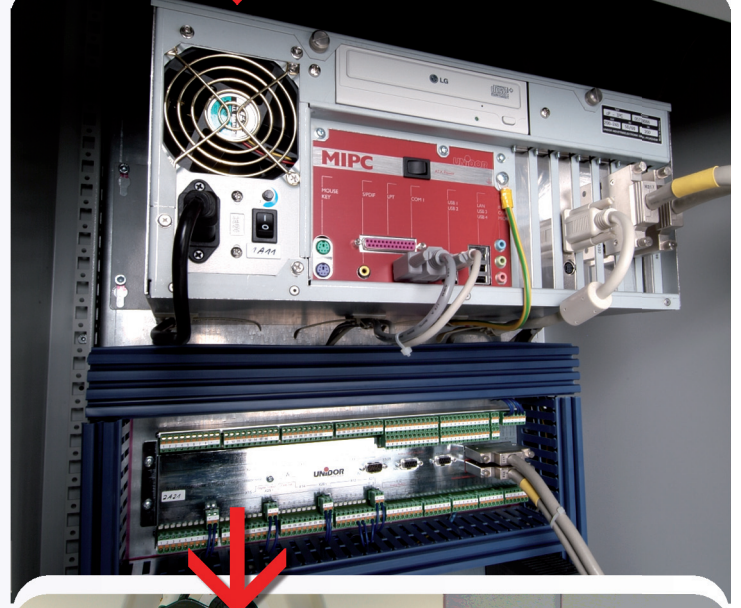
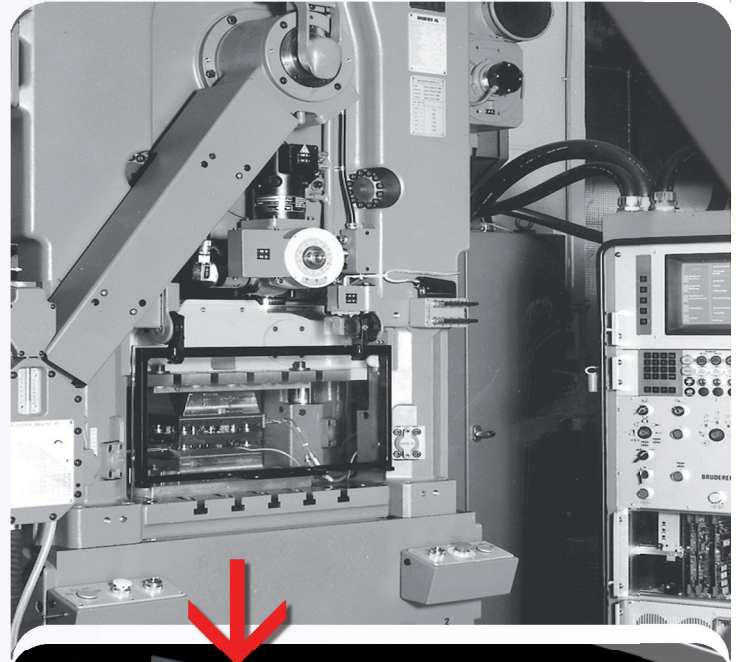

↑ the details

↑ the details



*unidor* is simply more than just the sum of its products

26



### *unidor*, who else?

More than 30 years of *unidor*, more than 30 years of technology for punching and forming technology. In the punch and press world we have not only successfully installed many thousands of systems worldwide, but have also played a leading role in the development and advancement of the technology. We were pioneers for much of what is state-of-the-art today.

We aim to continue to pursue this principle with energy and commitment true to motto "Every customer is our only customer".



## → Quality inside for all products

- We are QA certified in accordance with ISO 9001:2000
- All systems are subjected to a 48-hour continuous test under worst-case conditions. We also test in accordance with the national and international standards, e.g. GS and IEC, to name just two.
- Our products are not only of the highest profitability and reliability, but are also backed by comprehensive all-round service: From the applications advice through to user support, from the hotline through to service, from the manual through to training course – you can expect comprehensive individual support at all times.

## → Quality outside for service & advice







- Our innovations and perspectives for practical and market-oriented products are drawn from our ongoing intensive exchange of ideas and views with institutes, external experts and most importantly with our customers.
- Enthusiastic employees, specialists with vast know-how and initiative are hallmarks of the professionalism of our work from the development through the production and quality assurance right up to the service.
- When ever you need us, we are there for you: Dynamic, creative and enormously efficient. With all the experience of a successful company.

## → the unidor expert team

We can't do everything, but we understand a great deal about punching and forming. That is an area where we are professionals and reliable partners.

This special technology calls for professional experts with enormous competence and many years of experience. Only in this way can we achieve optimum results together. We guarantee you this know-how.

Service surrounding the product – from the applications advice through commissioning and training right up to service. *unidor* is simply more than just the sum of its products.

Function Contact	power PRESS	compact PRESS	
<b>Design &amp; Development</b> <i>Ullrich Hauser</i> tel 07231/3152 26 fax 07231/3152 99 ullrich.hauser@unidor.de	✓	✓	
<b>Applications Advice</b> <i>Roland Bott</i> tel 07231/3152 24 fax 07231/3152 99 roland.bott@unidor.de	✓	✓	
<b>Project Implementation</b> <i>Lars Jahn</i> tel 07231/3152 37 fax 07231/3152 99 lars.jahn@unidor.de		✓	
<b>Project Implementation</b> <i>Jürgen Kasper</i> tel 07231/3152 42 fax 07231/3152 99 jurgen.kasper@unidor.de	✓		
<b>Project Implementation</b> <i>Martin Neuner</i> tel 07231/3152 13 fax 07231/3152 99 martin.neuner@unidor.de		✓	
<b>Project Handling</b> <i>Stefan Sachs</i> tel 07231/3152 56 fax 07231/3152 99 stefan.sachs@unidor.de	✓	✓	



## **UNIDOR GmbH**

André Schuster  
ExportManagement  
Freiburger Straße 3  
D-75179 Pforzheim  
Phone +49 (0) 7231/3152 19  
Fax +49 (0) 7231/3152 48  
andre.schuster@unidor.de

## **AUSTRIA**

TR-Electronic GmbH  
Bergbaustraße 1  
A-8600 Bruck/Mur  
Phone: +43 (0)3862-550 06  
Fax: +43 (0)3862-55006 33  
info@tr-electronic.at

## **BRAZIL**

Autron Automação  
Indústria Comércio Ltda.  
Rua Cons. Brotero, 589 - 10ª  
BR-04105-001 São Paulo - SP  
Phone: +55 (011) 3815 6554  
Fax: +55 (011) 3815 4947  
info@ctecnologia.com.br

## **CANADA**

TR Electronic Inc.  
P.O.Box 2543, Station B  
CA-London, Ontario Canada N6A 4G9  
Phone: +1 519 4 52-19 99  
Fax: +1 519 4 52-11 77  
customercare@trelectronic.com

## **CHINA**

TR-Electronic GmbH  
Shanghai Rep.  
Office Rm102, #74  
Phoenix City  
3536 Nong Yin Du Road  
201108 Shanghai  
Phone: +86 21 5443 5113  
Fax: +86 21 5831 4829  
tr-electronic@online.sh.cn

## **CZECH REPUBLIC/SLOVAKIA**

Del a. s.  
Strojirenská 38  
CZ- 59101 Zďár Nad Sázavou  
Phone: +42 (0)566 642 257  
Fax: +42 (0)566 621 657  
del@del.cz

## **FRANCE**

TR-Electronic France  
56, Boulevard du Courcrerin  
F-77183 Croissy- Beaubourg  
Phone: +33 (0)16462-1313  
Fax: +33 (0)16462-2002  
info@tr-electronic.fr

## **DENMARK**

TR-Electronic Danmark ApS  
Hustedgardvej 22  
DK-8722 Hedensted  
Phone: +45 75890603  
Fax: +45 75890636  
mail@fh-gruppen.dk

## **GREAT BRITAIN**

Bruderer UK LTD.  
Cradock Road  
GB-Luton. Beds LU4 0SF  
Phone: +44 (0)1582 560 300  
Fax: +44 (0)1582 570 611  
mail@bruderer.co.uk

## **ITALY**

Telestar S.r.l.  
Via C. Colombo 13  
I-22069 Rovellasca (Co)  
Phone: +39 (0)2 96 74 02 68  
Fax: +39 (0)2 96 74 02 73  
telestar@telestar-automation.it

## **MALAYSIA/THAILAND**

Monkol Engineering  
Block 204 Hougang Str.21  
Singapore 530204  
Phone: +65 648 13678  
Fax: +65 648 13679  
mongkol@singnet.com.sg

## **NETHERLANDS/BELGIUM**

F. Hoffmann B. V.  
Gildenweg 25-35  
NL-3334 KC Zwijndrecht  
Phone: +31 (0)78 610 23 88  
Fax: +31 (0)78 6 10 32 55  
info@hoffmann-machines.nl

## **TURKEY**

Üniversa İç-Tic. ve Mak. San. Ltd. Sti.  
1203/4 Sok. No 5 Ege Ticaret Merkezi  
Yenisehir-IZMIR/Turkey  
TR-35110 Yenisehir, Izmir  
Phone: +90 232 4332909  
Fax: +90 232 4584631  
universa@superonline.com

## **SPAIN/PORTUGAL**

Intertronic Internacional, S.L.  
Azagador de la Torre, 67  
E-46006 Valencia  
Phone: +34 (96) 3 75 80 50  
Fax: +34 (96) 3 75 10 22  
info@intertronic.es

## **SINGAPORE**

Globaltec Pte. Ltd  
50, Bukit Batok Street 23  
#06-27 Midview Building  
Singapore 659578  
Phone: +65 626 79188  
Fax: +65 626 78011  
globaltec@pacific.net.sg

## **SWITZERLAND**

TR-Electronic SA  
14, Ch. Pré-Fleuri  
CH-1228 Plan-les-Ouates/Genève  
Phone: +41 (0)22-7 94 21 50  
Fax: +41 (0)22-7 94 21 71  
info@trelectronic.ch

## **SWEDEN**

TR-Electronic Sweden AB  
Enebybergsvägen 10B  
SE-182 36 Danderyd  
Phone: +46 (08) 756 72 20  
Fax: +46 (08) 756 76 80  
mailbox@trelectronic.se

## **POLAND**

Stoltronic-Polska Sp.z.o.o  
ul. Poniatowskiego 9/4  
PL- 87-100 Torun  
Phone: +48 56 651 0385  
Fax: +48 56 651 0384  
stoltronic@stoltronic.pl

## **USA**

TR-ELECTRONIC  
200 East Big Beaver Road  
Suite 164  
USA-Troy, MI 48083  
Phone: +1 248 244-2280  
Fax: +1 248 244-2283  
customercare@trelectronic.com

