

## Instructions for Use / Manual Load Amplifier Cassette LVCpro



TRsystems GmbH

Freiburgerstraße 3  
75179 Pforzheim  
Germany

Tel.: 07231 / 3152-0  
Fax: 07231 / 3152-99

email: [unidor@trsystems.de](mailto:unidor@trsystems.de)  
Web: <http://www.trsystems.de>



This user manual is kept up to date. As the TRsystems GmbH/ UNIDOR products are subject to continual development, technical modifications might lead to temporary deviations between the device design and the user manual. Please note that TRsystems GmbH is not liable for damages caused as a result of these deviations.

## View of LVCpro

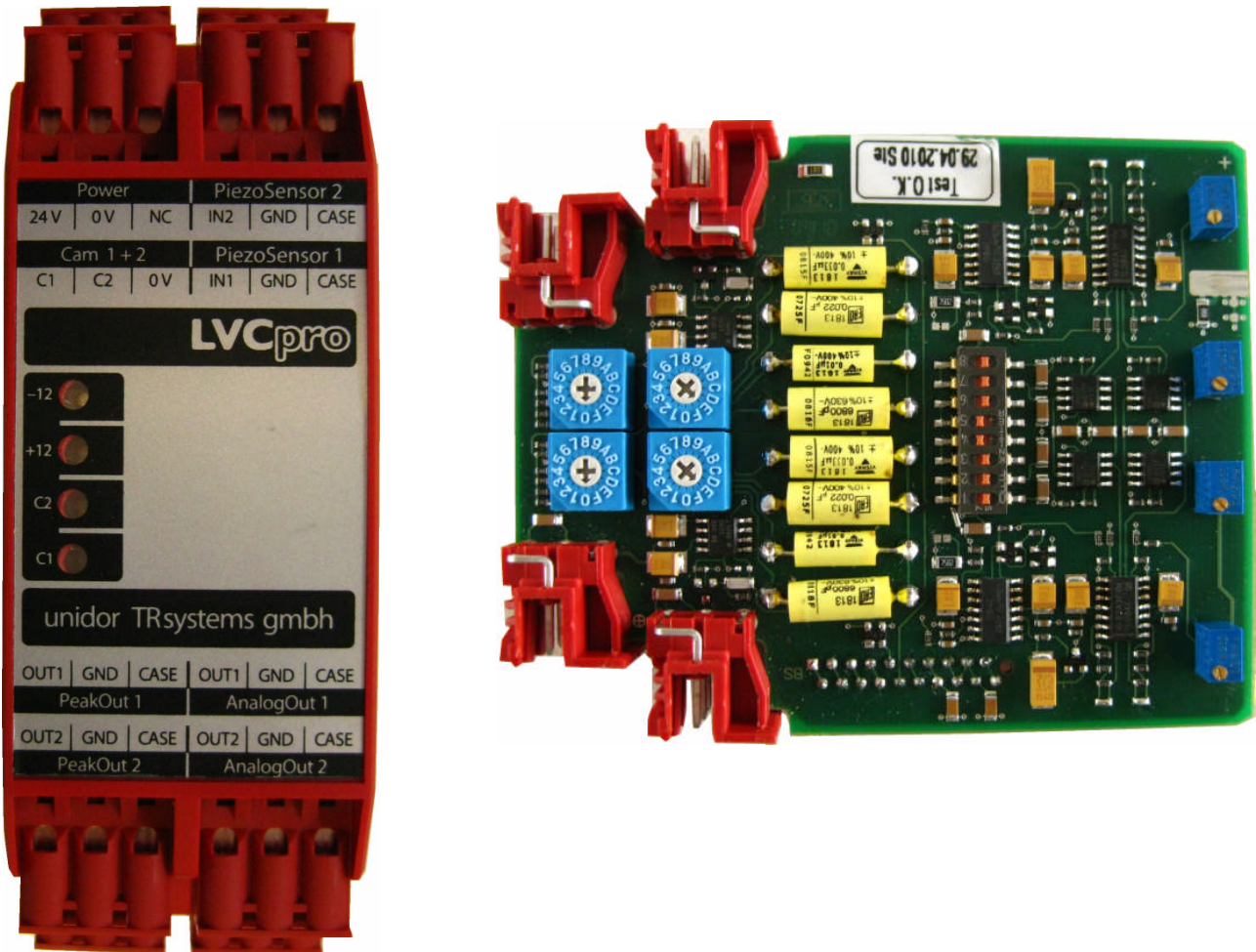

## Advantages

- Easy installation and wiring
- 24VDC supply voltage
- 2 measuring channels
- Peak value memory and current value available at the same time
- Switchable filter for suppression of disturbances

## Functionality

The load amplifier cassette enables a cost-efficient multichannel measurement of the press force by using piezo sensors.

Content		Page
1.	Safety Guidelines and Regulations	4 - 7
2.	Technical Specification	8
3.	Block Diagram	8
4.	Terminal Assignment	9
5.	Connector Coding	10
6.	Connection of the Piezo Sensors	11
7.	Setting of the Code Switches	12
8.	Amplification Factors	13
9.	Setting for DIP-Switches or Filters SW1	14
10.	Commissioning of the LVCpro	15
11.	Ordering Data LVCpro	16
12.	Mechanical Dimensions LVCpro	17
13.	Opening of the Enclosure LVCpro	18
14.	General Information	19

## 1. Safety Guidelines and Regulations

### ➤ Information on Guarantee and Liability



Our “general terms and conditions on sale and delivery” generally apply. These are available to the operator from the completion of the contract at the latest. Guarantee and liability claims for personal and material damages are excluded if caused by one or more of the following:

- Improper use of the device.
- Improper installation, commissioning, operation and maintenance of the device.
- Operation of the device or machines thereof with faulty safety equipment or with improper or inoperable safety and protection equipment.
- Failure to observe the regulations of the user manual.
- Unauthorised structural changes on the device or machines thereof.
- Unauthorised modifications to the settings of the initial operation.
- Insufficient control of parts subject to wear.
- Improper repairs of unqualified workers.
- Disaster situations caused by third parties or force majeure.

### ➤ Disclaimer / Right of Amendment



This user manual is kept up to date. As the TRsystems GmbH/ UNIDOR products are subject to continual development technical modifications might lead to temporary deviations between the device design and the user manual. Please note that TRsystems GmbH is not liable for damages caused as a result of these deviations.

### ➤ Due Diligence of the Operator



The LVCpro was designed and constructed following a risk analysis and upon careful selection of the relevant standards to be complied with, as well as other technical specifications. It is state-of-the-art and ensures the maximum possible safety during operation.

However, the machine safety can only be implemented if all necessary measures have been taken. The planning of these measures as well as the control of their implementation is part of the due diligence of the operator.

The operator must ensure that ...

- the machine is used in accordance with its intended purpose.
- necessary personal protective equipment for the operation, maintenance and repair is available and used.
- the machine is only operated, serviced and repaired by qualified personnel.



Furthermore the operator is responsible for ensuring that...

- this personnel is regularly trained in all relevant matters of occupational safety and environmental protection and knows the the contents of the user manual and especially the safety regulations therein.
- All safety and warning symbols attached to the machine must remain thereon and be clearly legible.



Only use the device:

- forthe intended purpose in safe conditions.
- interferences which impair the safety of the device, must be removed immediately.
- in an ambient temperature not exceeding a temperature range of 0 to 45°C.

#### ➤ Intended use



The device is exclusively intended for the control and measuring of the machines and equipment provided for this purpose. Any additional or further use is deemed as not being in accordance with the intended purpose. The company TRsystems / UNIDOR is not liable for damages caused following other usage.

Intended use also means:

- only using the device in immaculate condition.
- removing interferences which impair the safety of the device immediately!
- the risk ofinterference and damages of the device and the consequences caused by its peripheral devices is generally subject to the user.
- ensuring prior to the start-up of the device that nobody can impair the starting of the device. In case of malfunctions the device must be stopped and secured immediately.
- the monitoring of all control displays.

#### ➤ Obligations of the operator



- According to the electrical regulations, works on the electrical equipment shall only be implemented by skilled electricians.
- The safety-conscious work of the personnel will be monitored periodically. The user manual must be kept at all times ready to hand in close proximity of the machine/device.
- Modifications by the client or third parties require the written confirmation of the manufacturer. If a failure to observe leads to defects or malfunctions, the supplier and manufacturer will be excluded of the guarantee and liability.





- Guarantee and liability will also be void if defects of the device are not immediately notified to the supplier and appropriate measures for the damage control were implemented to late or not at all. Spare parts must correspond to the technical requirements defined by the manufacturer. Unauthorised modifications to the program and the control system are not allowed. The location and operation of extinguishers must be announced. The fire fighting measures and reporting possibilities must be adhered! Extinguishers must be suitable for the fire fighting of electrical fires.

➤ Safety Instructions for Maintenance and Servicing



- The equipments always must be isolated from the power supply when implementing maintenance, servicing or repairs.
- After completion of the work the functionality of the safety equipment must be checked.
- The relevant safety and accident prevention regulations apply for the corresponding situations.
- For 24VDC power supplies a safe, electric isolation of the low voltage is important. Only use power supplies designed acc. to IEC 364-4-41 respectively HD 384.04.41 (VDE 0100 part 410).
- Fluctuations or deviations of the mains voltage to the nominal value must not exceed the tolerance limits defined in the technical specification, as this might lead to malfunctions and hazardous conditions of the electric components.
- Connection and signal lines shall be installed in a way that inductive and capacitive interferences (disturbances, e.g. unshielded valves on the machines) do not impair the automation feature.



- Wiring as well as the opening and closing of electronic connections shall only be implemented on isolated machines!
- Short-circuits, voltage peaks, etc. can lead to malfunctions and uncontrolled conditions of the equipment and hence to severe personal and material damages.
- Check all the electric connections prior to the starting of the device!
- Incorrect connections can cause malfunctions of the device, faulty connections can cause severe personal and material damages.
- Do not replace components under voltage and do not open enclosures under voltage!
- Mechanical and/or electric modifications on our equipment are not permitted for security reasons!

➤ General Fault Clearance Measures / Shielding



- The use of electronic sensor active systems in modern equipment requires a consistent and correctly implemented fault clearance and wiring concept. The compliance with these requirements is important to ensure the proper function of a device with electronic measuring systems.
- Access lines must be laid for remote control and must be separated from supply lines stressed with disturbances (shielded).
- Ensure a continuous wiring of the shield as well as an extensive contact between the shield and the electric terminals.
- Cable crossings must be avoided. If inevitable exclusively square crossings shall be used.

➤ In Conclusion



All information is subject to change.  
The TRsystems GmbH / Unidor remains the right of modifications, especially regarding the states values, dimensions and weights as far as they are not stated elsewhere and lead to product improvements.

All our documentation is protected by copyright.  
The distribution to or the use by third parties, of parts or the entire documentation, requires the written confirmation of TRsystems GmbH/ Unidor.

## 2. Technical Specification

Power Supply	Input voltage: Input current:	10-32VDC / 24VDC nom. 90mA
Amplifier	Input resistance: Output resistance:	$10^{15} \Omega$ / Ohm 50 $\Omega$ / Ohm
Measuring Window Input / Cams	Input voltage: Input current: Function:	18-32VDC ca. 10mA at 24VDC active high = 1, Output low = 0 deletes analogous signal
Output Data	Output voltage: Output channels:	-10V to +10V 2
Dimensions (WxHxD)	Enclosure incl. connector	35 x 110 x 112mm

## 3. Block Diagram

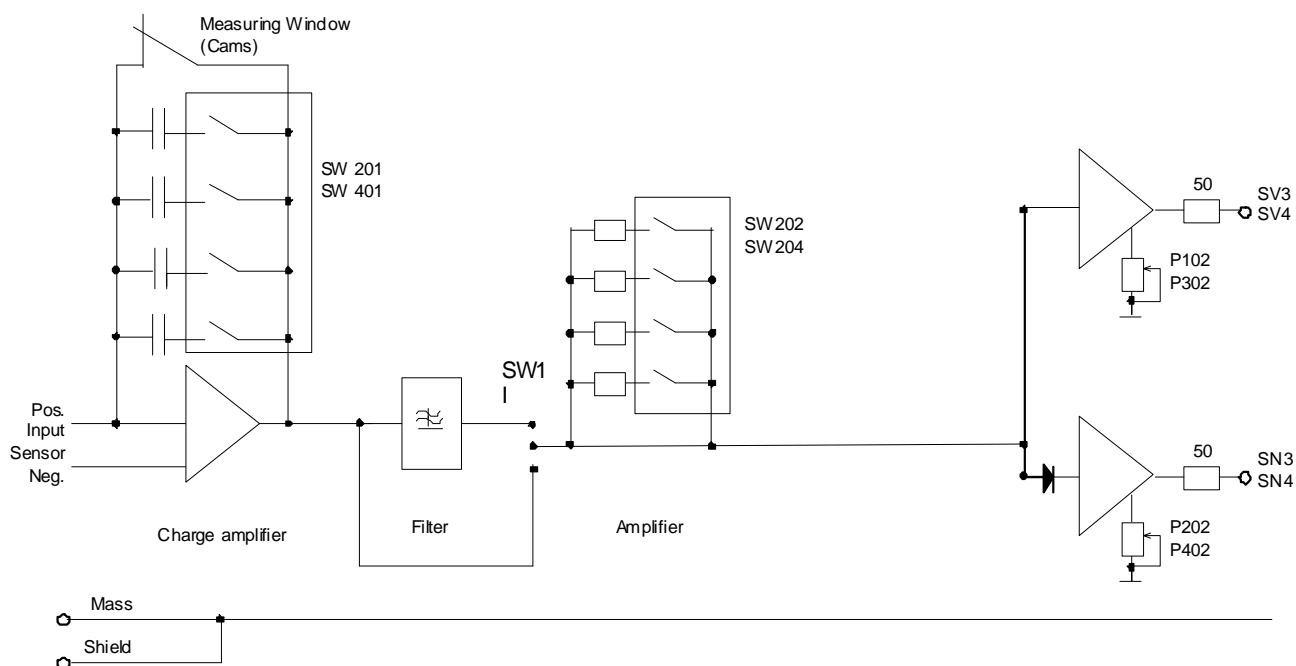



## 4. Terminal Assignment



upper connectors





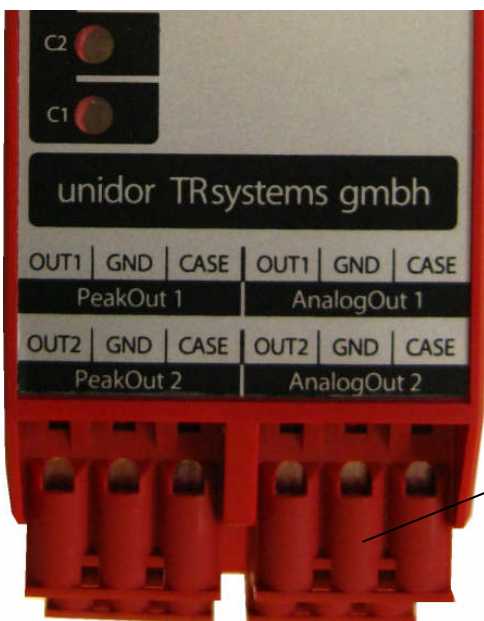

Connector	PIN	Function
Power	24V 0V NC	24VDC 0VDC not connected
CAM 1+2	C1 C2 0V	Cams 1/Meas. Channel 1 Cams 2/Meas. Channel 2 0VDC
PiezoSensor 2	IN2 GND CASE	Input Signal Sensor 2 Analogous-Mass Shield
PiezoSensor 1	IN1 GND CASE	Input Signal Sensor 1 Analogous-Mass Shield

bottom connectors

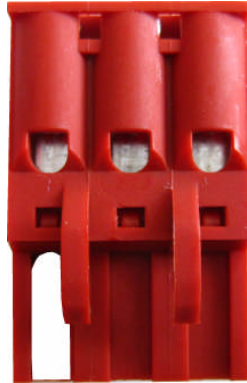

Connector	PIN	Function
PeakOut 1	OUT1 GND CASE	Peak Value Output 1 Analogous-Mass Shield
PeakOut 2	OUT2 GND CASE	Peak Value Output 2 Analogous-Mass Shield
AnalogOut1	OUT1 GND CASE	Output 1 / -10 to +10V Analogous-Mass Shield
AnalogOut2	OUT2 GND CASE	Output 2 / -10 to +10V Analogous-Mass Shield

## 5. Connector Coding

1x	1x	2x	4x
			
Power	CAM 1+2	PiezoSensor 1 PiezoSensor 2	PeakOut 1 + 2 AnalogOut1 + 2

## 6. Connection of the Piezo Sensors



### ➤ Sensor JZT127/S with black connection cable for rack mounting

#### Terminal assignment for pressure load

Sensors	Connector LVCpro	Core Colour	PIN
Press Force Sensor 1	PiezoSensor 1	black	IN1
		red	GND
		Shield	CASE
Press Force Sensor 2	PiezoSensor 2	black	IN2
		red	GND
		Shield	CASE

#### Terminal assignment for tensile load

Sensors	Connector LVCpro	Core Colour	PIN
Press Force Sensor 1	Piezosensor 1	red	IN1
		black	GND
		Shield	CASE
Press Force Sensor 2	Piezosensor 2	red	IN2
		black	GND
		Shield	CASE

### ➤ Sensor JZT127/P with white connection cable for rod mounting

#### Terminal assignment for pressure load

Sensors	Connector LVCpro	Connector	PIN
Press Force Sensor 1	Piezosensor 1	black	IN1
		white	GND
		Shield	CASE
Press Force Sensor 2	Piezosensor 2	black	IN2
		white	GND
		Shield	CASE

#### Terminal assignment for tensile load

Sensors	Core Colour	Connector	PIN
Press Force Sensor 1	Piezosensor 1	white	IN1
		black	GND
		Shield	CASE
Press Force Sensor 2	Piezosensor 1	white	IN2
		black	GND
		Shield	CASE

## 7. Setting of the Code-Switches



The adjustment of the analogues inputs and outputs will be implemented through hexadecimal code and DIP-switches.

The adjustments will be implemented separately for each channel.

Channel / Sensor	Code-Switch	Function
<u>Channel 1 + 2</u>	SW1	Filter adjustment
<u>Channel 1</u> Piezo Sensor 1	SW201 SW202  P102 P202	Code-switch for capacitive (rough) amplification Code-switch for amplification adjustment(fine)  Offset analogues output 1 Offset analogues output peak value 1
<u>Channel 2</u> Piezo Sensor 2	SW401 SW402  P302 P402	Code-switch for capacitive (rough) amplification Code-switch for amplification adjustment(fine)  Offset analogues output 2 Offset analogues output peak value 2

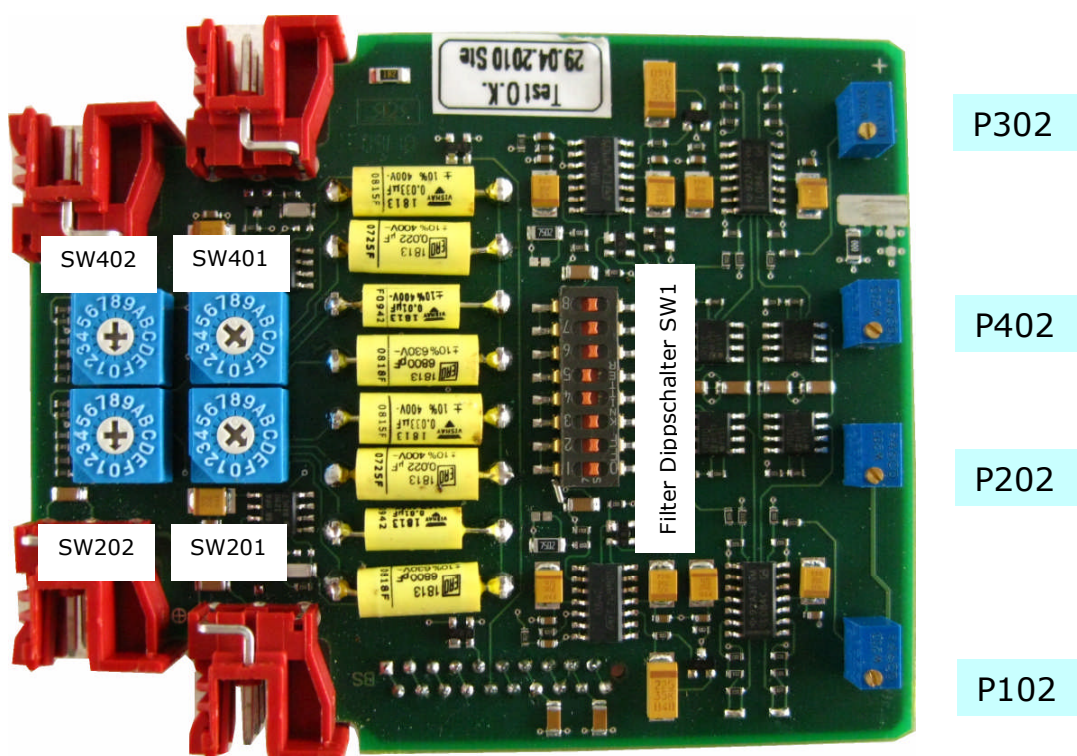

## 7. Amplification Factors

### Rough Adjustment

Capacitive amplification Code-switch SW201, SW401	Capacity (nF)
0	71.8
1	65.0
2	61.8
3	55.0
4	49.8
5	43.0
6	39.8
7	33.0
8	38.8
9	32.0
A	28.8
B	22.0
C	16.8
D	10.0
E	6.8
F*	0.0

### Fine Adjustment

Amplification Adjustment Code-switch SW202, SW402	Amplification factor (times)
0	11.12
1	11.08
2	11.03
3	10.96
4	10.93
5	10.84
6	10.76
7	10.64
8	10.48
9	10.27
A	10.07
B	9.67
C	9.51
D	8.80
E	7.90
F	5.27

\* not permitted code-switch adjustments

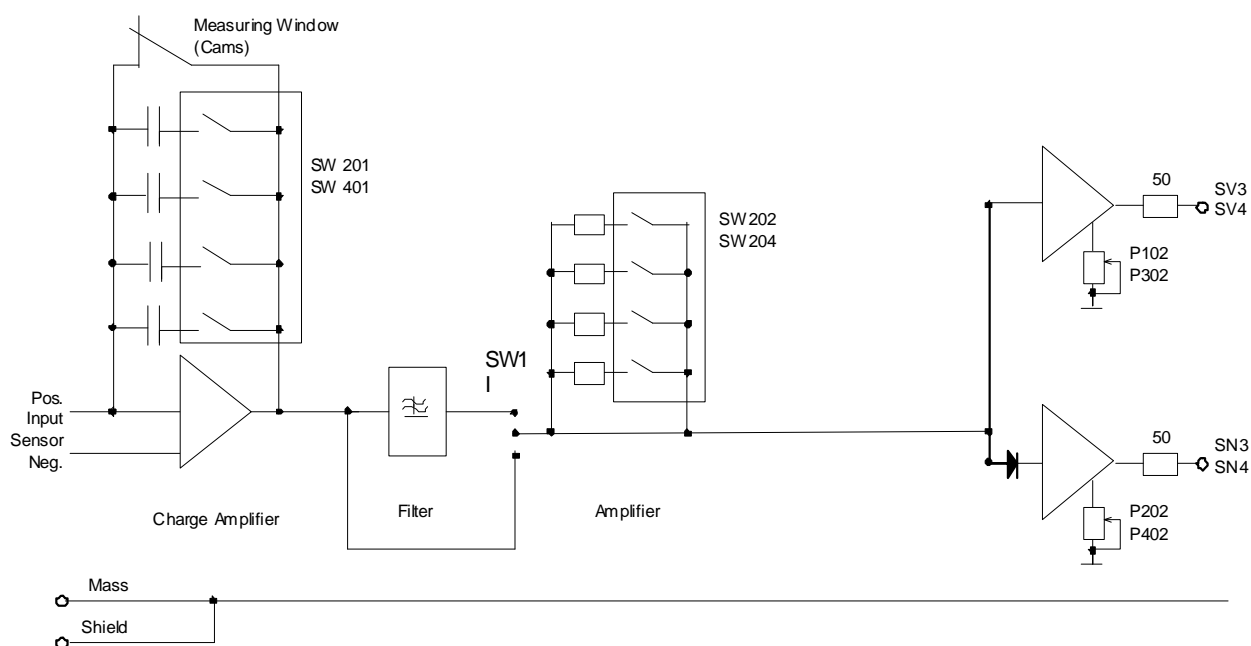







## 8. Settings for DIP-Switches or Filters SW1

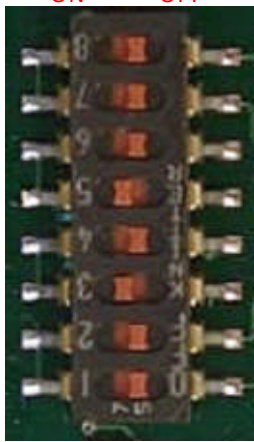

### Channel 1 / Piezo Sensor 1

	DIP-Switch	Function	
 <p>(Default) Factory setting with filter, F-limit = 1KHz</p>	1+2	Turn on either only switch 1 or switch 2 , or neither of them!  F-limit = 1KHz (33nF) (Default 1+2= OFF)	
	1	F-limit = 100Hz (220nF II 33nF) (1=ON,2=OFF)	
	2	F-limit = 355Hz (47nF II 33nF) (2=ON,1=OFF)	
		Caution: Only switch 3 or switch 4 on ON, never both at the same time as this might lead to malfunctions or damages to the electronics.	
	3	with filter (Default 3=ON , 4=OFF)	
	4	without filter (4=ON , 3=OFF)	

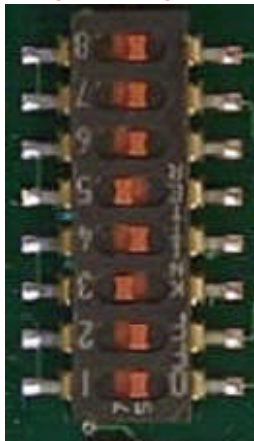
### Channel 2 / Piezo Sensor 2

	DIP-Switch	Function	
 <p>(Default) Factory setting with filter, F-limit = 1KHz</p>		Caution: Only switch 5 or switch 6 on ON, never both at the same time, as this might cause malfunctions or damages to the electronics.	
	5	with filter (Default 5=ON , 6=OFF)	
	6	without filter (6=ON , 5=OFF)	
	7+8	Turn on either only switch 7 or switch 8, or neither of them!  F-limit = 1KHz (33nF) (Default 7+8= OFF)	
	7	F-limit = 100Hz (220nF II 33nF) (7=ON,8=OFF)	
	8	F-limit = 355Hz (47nF II 33nF) (8=ON,7=OFF)	



---

---

--	--	--	--

---

## 9. Commissioning of the LVCpro



➤ Wiring of the piezo sensors. Wire the measuring window and the outputs according to the PIN-assignment. Apply supply voltage (it is important to use the correct polarity!)

➤ Alignment (calibration) of the amplifiers with the piezo sensors used acc. to the table in chapter 6.

➤ For the code-switches SW201 (channel 1) or SW401 (channel 2) it is possible to adjust different sensitivities of the sensors against the basic adjustments, when working in a multichannel version of the measurement.

➤ Adjustment of the amplification factor acc. to chapter 9 with the relevant code-switches SW202 (channel 1) or SW402 (channel 2) on the basic position 3.

➤ Adjust the maximum output of the measurement object (e.g. the maximum press force). Continuously up-shift the code-switch SW201 (channel 1) respectively SW401 (channel 2) until reaching the desired output voltage on the analogous output (max. 10V). We recommend a final adjustment of 7V output voltage for maximum load to still enable an assessment in case of an overload.

➤ If replacing the load amplifier cassette LVCpro it is important to maintain the same adjustment of the code-switches, otherwise there is the risk of overload (falsification of the measuring results)!

## 10. Ordering Data LVCpro

<u>Article description</u>	<u>Type</u>	<u>Order-No.:</u>
Load Amplification Cassette, 2-channel	LVCpro 02	10 40 4102 0000
Load Amplification Cassette, 2-channel (low amplification / sensitivity)	LVCpro 02-G	10 40 4202 0000
Press Force Sensor black sheath (rack mounting) with 6m* connection cable	JZT 127 / S	50 01 01 01 0000
Press Force Sensor white sheath (rod mounting) with 6m*connection cable	JZT 127 / P	50 01 01 06 0000
Coaxial Cable , open ends on both sides(by the meter)	MIL-C-17F-RG 058 CU	64200120

- additional cable length available on request

## 11. Mechanical Dimensions of the LVCpro

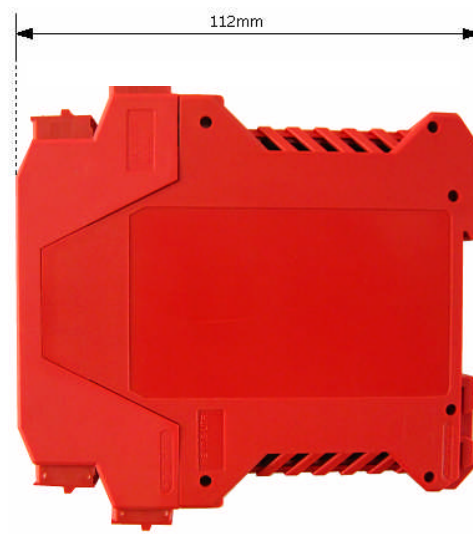

## 12. Opening the LVCpro Enclosure

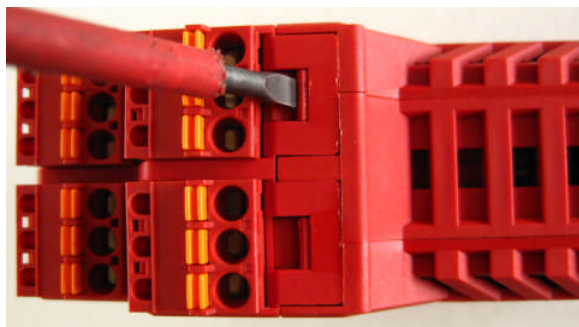

1. Use a screwdriver to push the splint in the opening tab down, located underneath the connector plugs of Power, PiezzoSensor2 and underneath PeakOut2 and AnalogOut2.

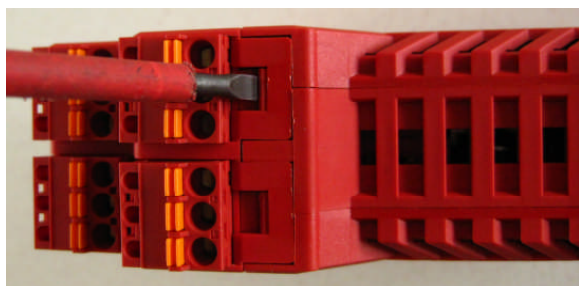

2. Using the screwdriver, push the splint down from the locked closure tab

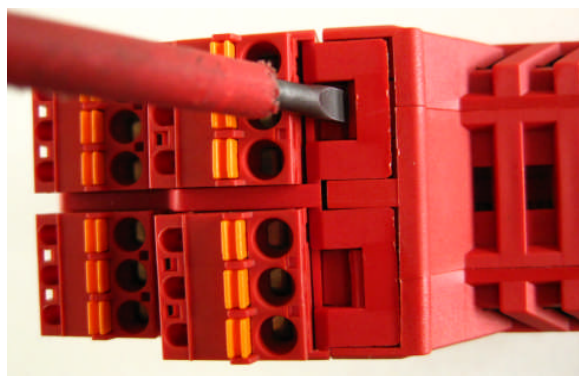

3. ...and push it backwards at the same time. Now repeat these steps for all 4 tabs to remove the entire enclosure lid.

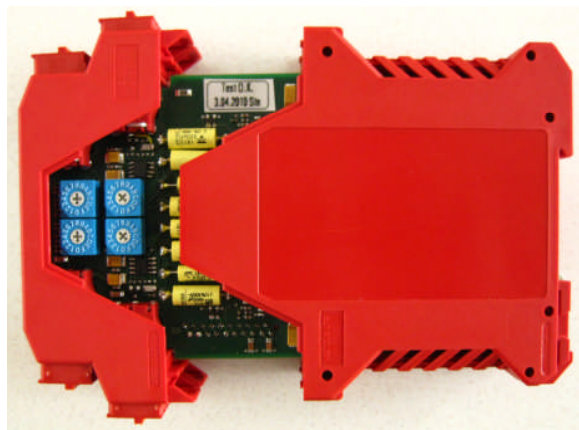

4. You can now open the LVCpro and the code-switches for the adjustment and/or calibration of the press force are accessible.

---

## 14. General Information

---

### EC-Declaration of Conformity

---

Manufacturer: TRsystems GmbH , System Division Unidor

Factory: Unidor , Freiburger Straße 3, 75179 Pforzheim

---

certifies for the

---

Product: Load Amplifier

Device Type: LVCpro

Model-Name: LVCpro 02 , LVCpro 02-G

---

the confirmation of the EC Directive 89/392/EWG and the following standards:

- EN 60 204.1, electrical equipment for industrial machines
  - Electromagnetic Compatibility 89/336/EWG IEC 801 parts 1,2,4
  - EN 55011 Conducted Emissions
  - EN 55022 Radio Radiation
  - VDE 0100, VDE 0113, EN 60204
- 

Issued by: TRsystems GmbH , System Division Unidor

Date: 26 May 2010

Place: Pforzheim, Germany

---

